



iPad (10th generation) Wi-Fi

iPad (10th generation) Wi-Fi + Cellular

Apple Recycler Guide

June 2023

Contents

3	About This Guide
4	Identification
5	Directive 2012/19/EU Annex VII Components
6	Safety Considerations
9	Recommended Tools
10	Disassembly Instructions
23	Material Categorization of Output Fractions

About This Guide

Apple Recycler Guides provide guidance for electronics recyclers on how to disassemble products to maximize recovery of resources. The guides provide step-by-step disassembly instructions and information on the material composition to help recyclers direct fractions to the appropriate material recycler.

To conserve important resources, we work to reduce the materials we use and aim to one day source only recycled or renewable materials in our products. A key path to reaching that goal is resource recovery from end-of-life electronics.

Disassembly procedures are intended to be performed only by trained electronics recycling professionals. The recycler is responsible for independently evaluating and ensuring compliance with all applicable environmental, health, and safety laws related to the work. These include but are not limited to laws relating to the management, handling, shipping, and disposal of the outputs of this work as waste and laws in place to ensure the health and safety of all employees who support this work.

For questions or feedback about this guide, email contactesci@apple.com.

Note: This guide may show images from other similar models, but the procedures are the same.

Identification

You can find the model number on the back of the iPad (10th generation).

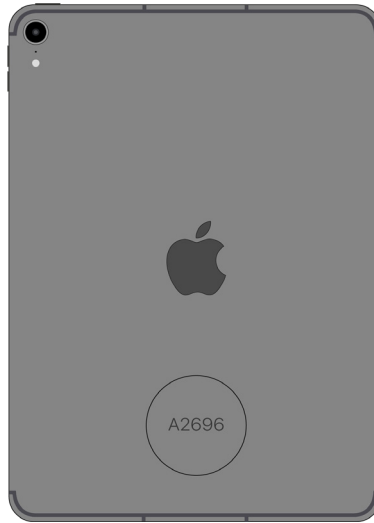

Model numbers:

(Wi-Fi) A2696

(Wi-Fi + Cellular) A2757, A2777

Directive 2012/19/EU Annex VII Components

Directive 2012/19/EU Annex VII requirements apply to the following substances and components.

Substance/Component	Apple Part Name	Removal Instructions
Printed circuit board if the surface is greater than 10 square centimeters	Display logic board, main logic board	Follow steps 1–8
External electric cables	Power adapter, charge cable	Follow step 1
Battery	Lithium-ion polymer batteries	Follow steps 1–4
Cover glass and liquid crystal display (LCD) cell if the surface is greater than 100 square centimeters	LCD cell	Follow steps 1–3
No further substances or components as listed in Annex VII		

Safety Considerations

The recycler is responsible for independently evaluating all activities undertaken by its employees to perform or support the work and ensuring compliance with all applicable health and safety laws related to the work. These include but are not limited to laws relating to the health and safety of all employees who perform or support this work. The recycler is also responsible for evaluating the workspace and ensuring that the area in which the work is to be undertaken is designed using ergonomic best practices and meets all ergonomic requirements to ensure the protection of its employees.

Personal Protective Equipment

Personal protective equipment should be worn during the entire recycling process.



Wear eye protection



Wear protective clothing



Wear hand protection



Wear foot protection

Battery Safety

This product uses a lithium-ion polymer battery. Before beginning any disassembly work, ensure that a safe working procedure for handling lithium-ion batteries has been established, which could include discharging the batteries so that they can be more safely managed. The following considerations may also be included:

- Remove anything from your person that could conduct energy, such as jewelry and watches, to avoid electric shock to yourself or the logic board.
- To avoid the potential for thermal runaway and the release of potentially noxious fumes, don't puncture, strike, or crush lithium-ion polymer batteries or devices powered by them.
- Don't throw, drop, or bend the battery.
- Don't expose the battery to excessive heat or sunlight.
- Don't use tools that are sharp or conduct electricity.
- Keep your workspace clear of foreign objects and sharp materials.
- Dispose of batteries according to local environmental laws and guidelines.

Workspace safety guidelines

- Use heat-resistant gloves and safety glasses.
- Keep a sand dispenser within arm's reach (2 feet or 0.6 m) on one side of the workstation, not above the workstation. The dispenser should be a wide-mouthed, quick-pour metal container with a flip-top lid or tray that contains 8–10 cups (1.9–2.4 L) of clean, dry, untreated sand.
- Keep the battery at least 2 feet (0.6 m) from paper and other combustible materials.
- Work in an area with adequate ventilation.

Handling a thermal runaway

If you notice any of the following signs, a thermal runaway is likely underway, and you should act immediately:

- The lithium-ion polymer battery or a device containing one begins to smoke or emit sparks or soot.
- The battery pouch suddenly and quickly puffs out.
- You hear hissing or popping sounds.

Don't use water or an ABC/CO₂ fire extinguisher on a thermal runaway battery or a device containing one. Water and ABC/CO₂ fire extinguishers will not stop the reaction.

Do smother the battery or device immediately with plenty of clean, dry sand, dumped all at once. Timing is critical; the faster you pour all the sand, the faster the thermal runaway will stop.

Do leave the room for 30 minutes if the thermal runaway causes any irritation.

Do wait 30 minutes before touching the battery. Wear heat-resistant gloves and safety glasses to remove the battery from the sand, or use a touchless thermometer to measure the battery temperature. Only touch the battery when the event has finished.

Do dispose of the damaged battery or device (including any debris removed from the sand) according to local environmental laws and guidelines.

Hazard Warnings



Broken glass hazard



Chemical exposure hazard



Rechargeable battery hazard

Recommended Tools

Miniature pry bar

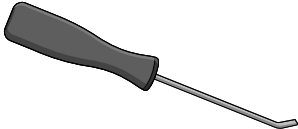

Nail-pulling screwdriver

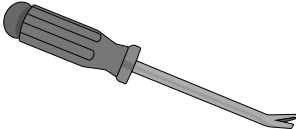

Plastic pry bar

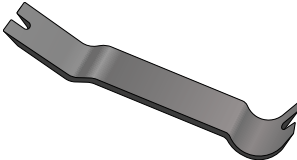

Precision slotted screwdriver

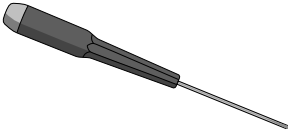

Screwdriver-handle pry bar

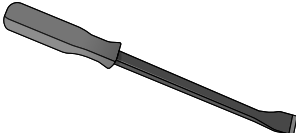

Slip-joint pliers

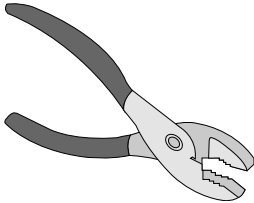

Tweezers



Disassembly Instructions

1. Remove the power adapter and the charge cable.

- » *Ensure that the iPad is turned off.*
- » *Unplug the power adapter. Disconnect both ends of the charge cable.*

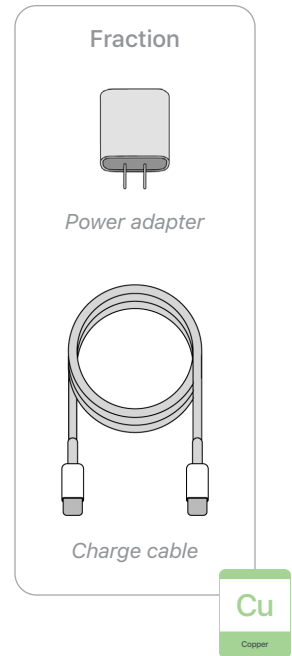

2. Remove the display.



Broken glass hazard



Chemical exposure hazard

Tools Used

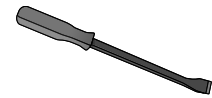

- » *Hold the iPad at the edge of a counter with the display facing up.*
- » *Insert the tool tip into the bottom of the display. Push the handle down to pry the display from the enclosure.*

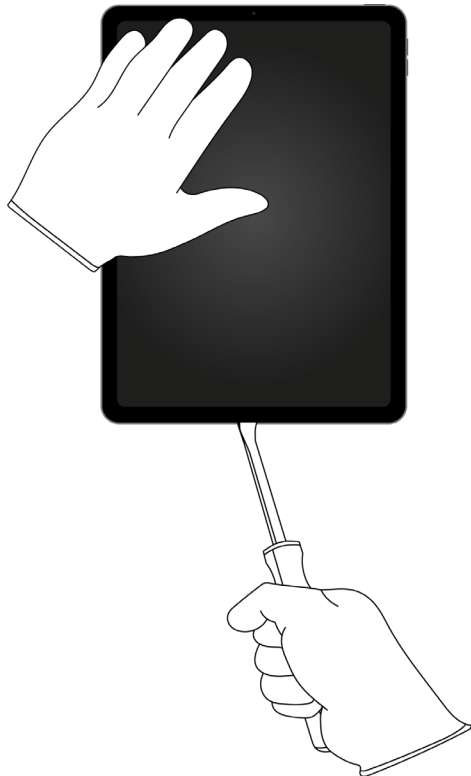

- » *Remove the display by hand. Set the enclosure aside.*

3. Separate the display logic board from the LCD cell.

- » Lay the display facedown.
- » Pry the display logic board off the LCD cell.

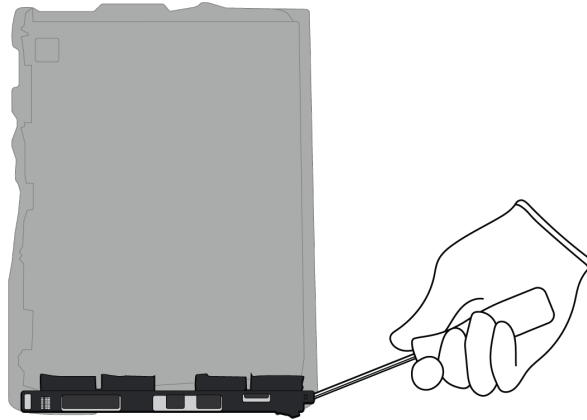

Tools Used



Fraction



Display logic board

PMs

Precious Metals

Fraction

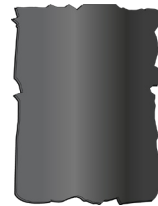

LCD cell

GL

Glass

4. From the enclosure, carefully remove both lithium-ion polymer batteries.



Rechargeable battery hazard

- » For each battery, use tweezers to gently peel one of the battery adhesive tabs away from the battery.
- » Twist the tab around the tweezers until white adhesive appears. Continue twisting until the entire adhesive strip is removed.
- » Repeat this process for the remaining battery tabs. Continue with the plastic pry bar if needed.

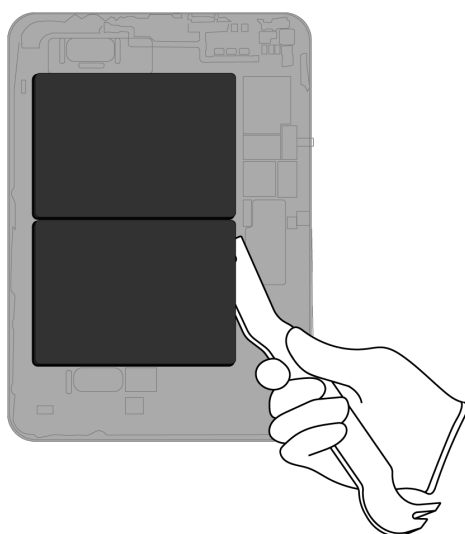

Tools Used



Fraction



Lithium-ion polymer batteries

BT

Battery

5. Pry off the upper speaker.

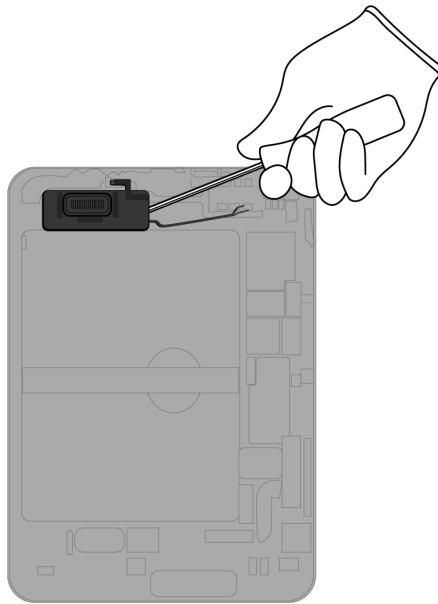

Tools Used



Fraction



Upper speaker



6. Remove the camera covers.

» *Pry off the rear camera ribbon cover.*

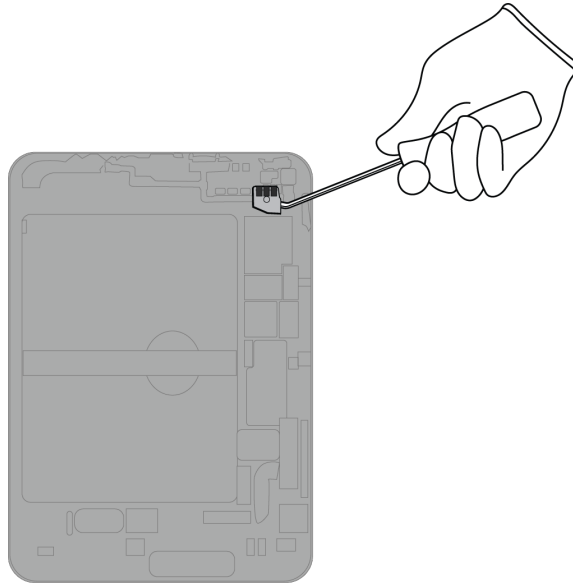

Tools Used



Fraction

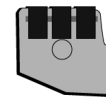

Rear camera ribbon cover

Fe

Ferrous

» *Pry off the rear camera cover.*

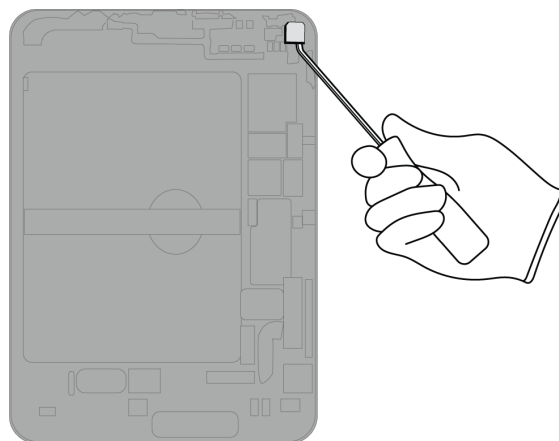

Fraction

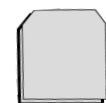

Rear camera cover

Fe

Ferrous

7. Pry off the rear camera.

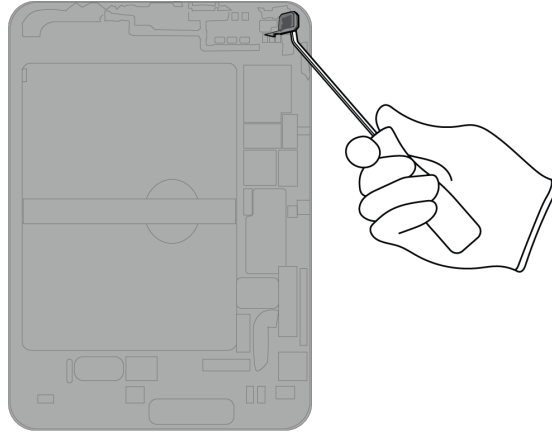

Tools Used



Fraction



Rear camera



8. Pry off the main logic board.

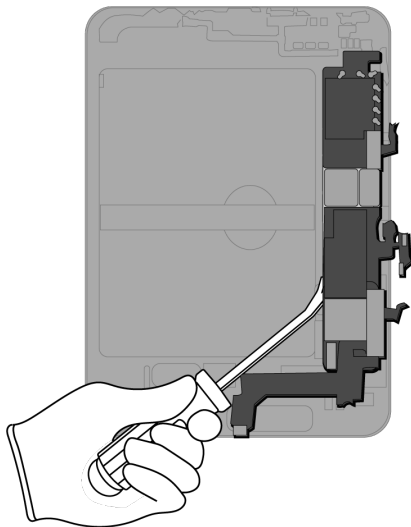

Tools Used

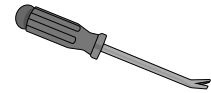

Fraction

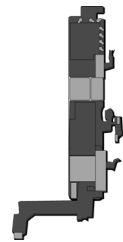

Main logic board



9. Pry off the microphone.

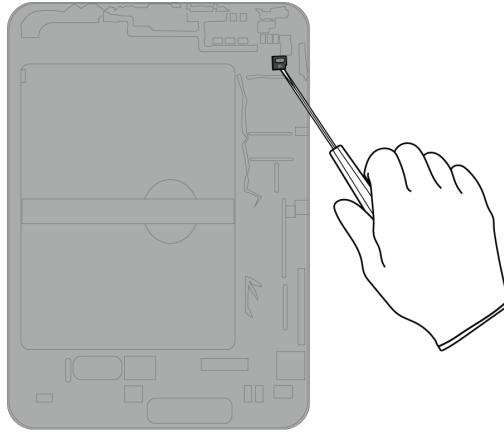

Tools Used

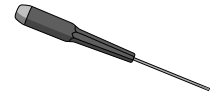

Fraction



Microphone

Cu
Copper

10. Pry off the light sensor.

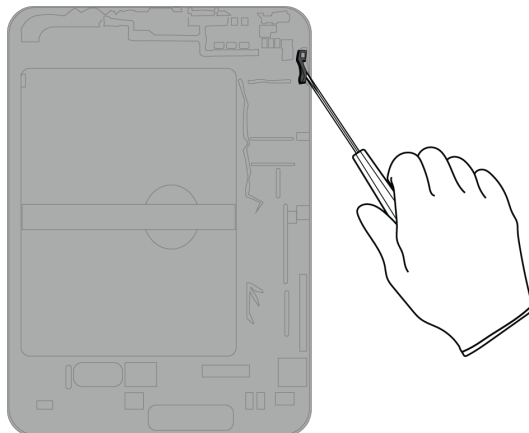

Tools Used

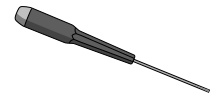

Fraction



Light sensor

Cu
Copper

- 11.** (Cellular models only) Remove the SIM tray.
Separate the SIM card from the SIM tray.

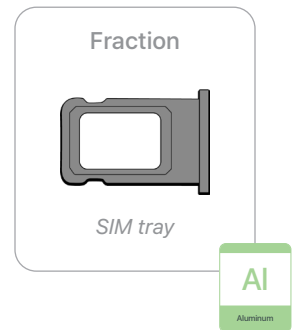
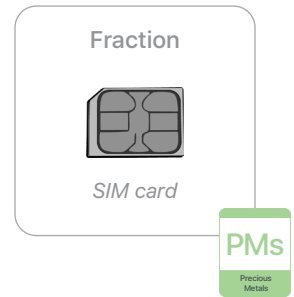
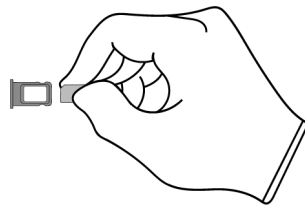
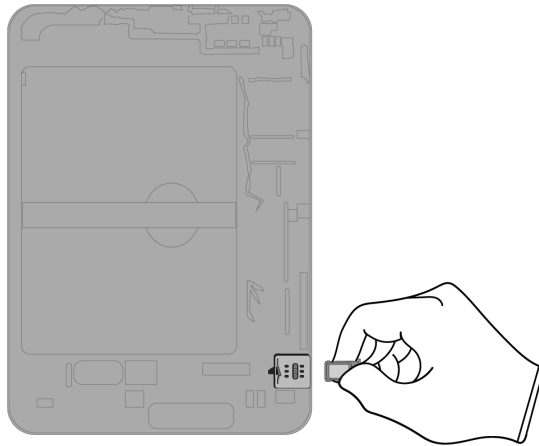

12. (Cellular models only) Pry off the SIM reader.

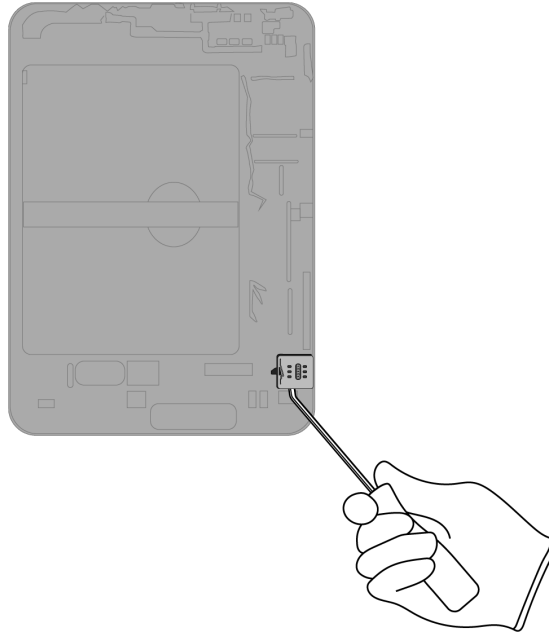

Tools Used



Fraction



SIM reader

Cu
Copper

13. Pry off the lower speaker.

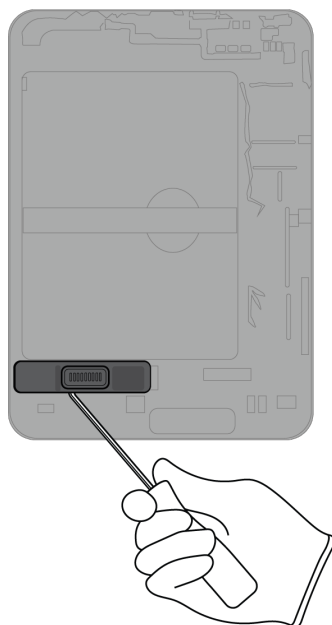

Tools Used



Fraction



Lower speaker

REE
Rare Earth
Elements

14. Pry off both antennas.

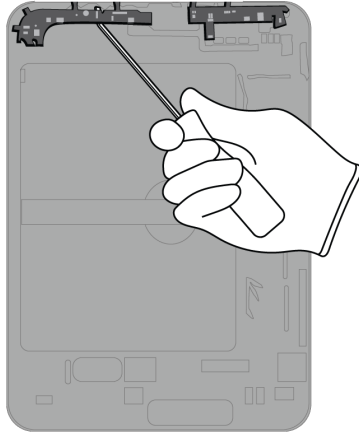

Tools Used



Fraction

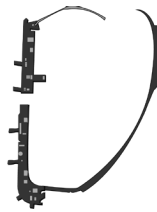

Antennas

Cu

Copper

15. Pry off the display mounting bracket.

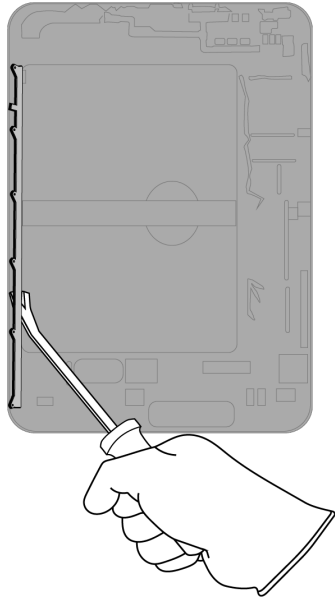

Tools Used

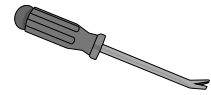

Fraction



Display mounting bracket

Al

Aluminum

16. Pull off the ribbon cables and wires.

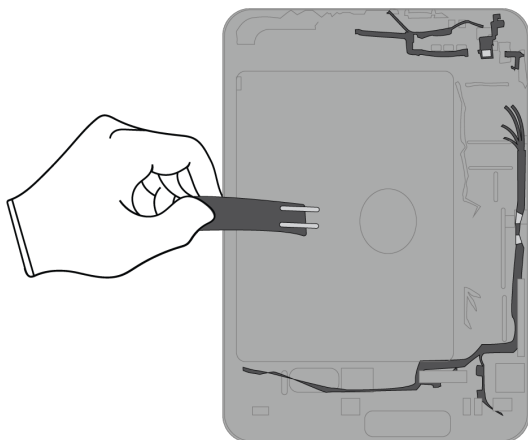

Fraction



Ribbon cables and wires

Cu

Copper

17. Remove the magnets.

» Bend both sides of the enclosure.

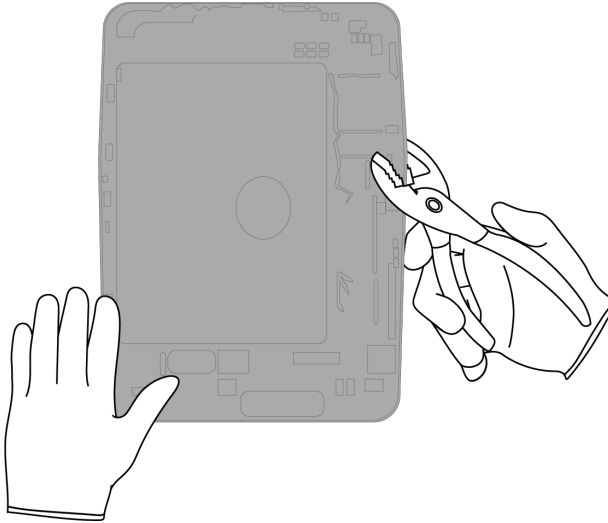

Tools Used

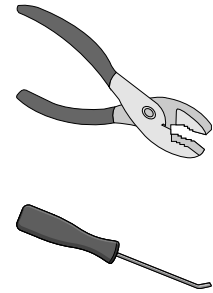

» Pry the 42 magnets from three sides of the enclosure.

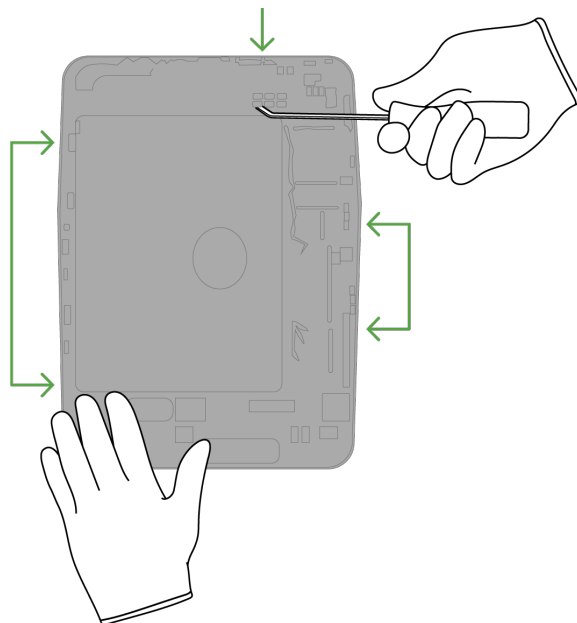

Fraction

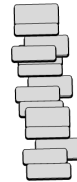

Magnets (x42)

REE
Rare Earth Elements

Fraction

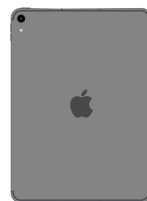







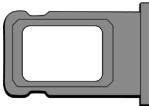

Enclosure

Al
Aluminum

Material Categorization of Output Fractions

All outputs from this process must be managed, handled, and disposed of in accordance with applicable waste laws and regulations, including but not limited to the Waste Framework Directive and its national enactments in Europe.

Fraction	Downstream Processing
<p data-bbox="435 604 570 632">Aluminum</p>  <p data-bbox="459 806 542 833"><i>SIM tray</i></p>  <p data-bbox="378 942 621 970"><i>Display mounting bracket</i></p>  <p data-bbox="451 1234 552 1262"><i>Enclosure</i></p>	<p data-bbox="964 604 1276 632">Primary Target Material</p>  <p data-bbox="925 856 1315 884">Potential Additional Materials</p>  
<p data-bbox="440 1352 565 1379">Batteries</p>  <p data-bbox="358 1583 643 1610"><i>Lithium-ion polymer batteries</i></p>	<p data-bbox="964 1352 1276 1379">Primary Target Material</p> 

Fraction

Downstream Processing

Ferrous

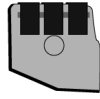

Rear camera ribbon cover



Rear camera cover

Primary Target Material



Glass



LCD cell

Primary Target Material



Potential Additional Materials



Fraction

Downstream Processing

Logic Boards



Display logic board



Rear camera

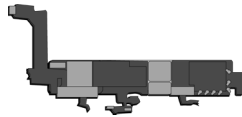

Main logic board



SIM card

Primary Target Material



Potential Additional Materials



Fraction

Downstream Processing

Mixed Electronics

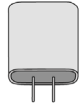

Power adapter

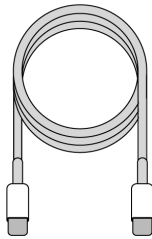

Charge cable



Microphone



Light sensor



SIM reader

Primary Target Material



Potential Additional Materials



Mixed Electronics (cont.)



Antennas

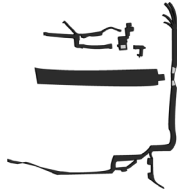

Ribbon cables and wires

Rare Earth Magnets



Upper speaker



Lower speaker

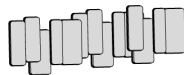

Magnets (x42)

Primary Target Material



Potential Additional Materials



Version	Date	Name	Comments
V1	03/17/23	Debbie Downs	Layout 1
V2	04/07/23	Debbie Downs	V1a edits completed
V3	04/20/23	Debbie Downs	V2a edits completed; updated some illustrations
V4	05/02/23	Debbie Downs	V3a edits completed; updated some illustrations
V5	05/03	Debbie Downs	V4a edits completed, updated illustration
V6	06/01/23	Debbie Downs	V5a edits done