



# Mac Pro (2019)

## Apple Recycler Guide

May 2023

# Contents

3	<a href="#">About This Guide</a>
4	<a href="#">Identification</a>
5	<a href="#">Directive 2012/19/EU Annex VII Components</a>
6	<a href="#">Safety Considerations</a>
7	<a href="#">Recommended Tools</a>
8	<a href="#">Disassembly Instructions</a>
52	<a href="#">Material Categorization of Output Fractions</a>

# About This Guide

Apple Recycler Guides provide guidance for electronics recyclers on how to disassemble products to maximize recovery of resources. The guides provide step-by-step disassembly instructions and information on the material composition to help recyclers direct fractions to the appropriate material recycler.

To conserve important resources, we work to reduce the materials we use and aim to one day source only recycled or renewable materials in our products. A key path to reaching that goal is resource recovery from end-of-life electronics.

Disassembly procedures are intended to be performed only by trained electronics recycling professionals. The recycler is responsible for independently evaluating and ensuring compliance with all applicable environmental, health, and safety laws related to the work. These include but are not limited to laws relating to the management, handling, shipping, and disposal of the outputs of this work as waste and laws in place to ensure the health and safety of all employees who support this work.

For questions or feedback about this guide, email [contactesci@apple.com](mailto:contactesci@apple.com).

# Identification

You can find the model number of the Mac Pro (2019) underneath the bottom plate.

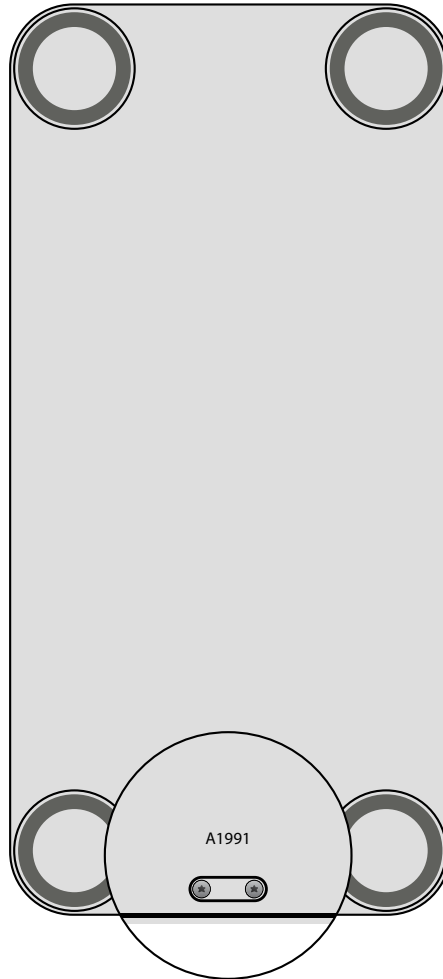

*Model number:  
A1991*

# Directive 2012/19/EU Annex VII Components

Directive 2012/19/EU Annex VII requirements apply to the following substances and components.

Substance/Component	Apple Part Name	Removal Instructions
Printed circuit board if the surface is greater than 10 square centimeters	Graphics processing unit (GPU) logic board, power supply logic board, memory modules, processor, input/output (I/O) card, main logic board	Follow steps 1–36
External electric cables	Power cord	Follow step 1
Battery	Coin cell battery	Follow steps 1–11
No further substances or components as listed in Annex VII		

# Safety Considerations

The recycler is responsible for independently evaluating all activities undertaken by its employees to perform or support the work and ensuring compliance with all applicable health and safety laws related to the work. These include but are not limited to laws relating to the health and safety of all employees who perform or support this work. The recycler is also responsible for evaluating the workspace and ensuring that the area in which the work is to be undertaken is designed using ergonomic best practices and meets all ergonomic requirements to ensure the protection of its employees.

## Personal Protective Equipment

Personal protective equipment should be worn during the entire recycling process.



Wear hand protection



Wear eye protection



Wear protective clothing



Wear foot protection

## Hazard Warnings



Crushing hazard



Sharp edges—cut hazard



Heavy weight hazard

# Recommended Tools

4 mm L-key

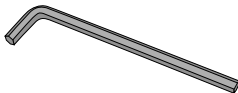

Miniature pry bar

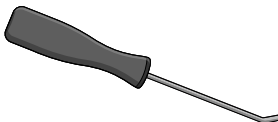

Nail-pulling screwdriver

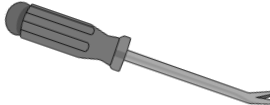

Phillips screwdriver

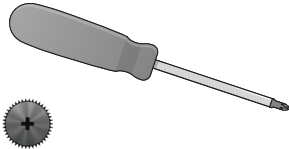

Screwdriver-handle pry bar

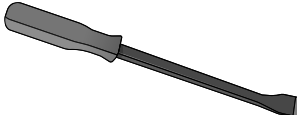

Torx T5 screwdriver

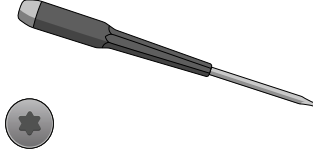

Torx T8 screwdriver

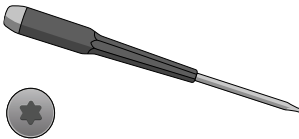

Torx T15 screwdriver

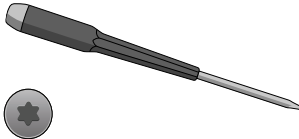

Wire cutters

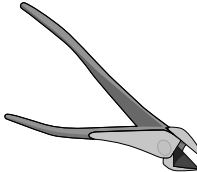

# Disassembly Instructions

## 1. Remove the power cord.

» *Ensure that the Mac Pro is turned off.*



» *Unplug the power cord from the back of the computer.*

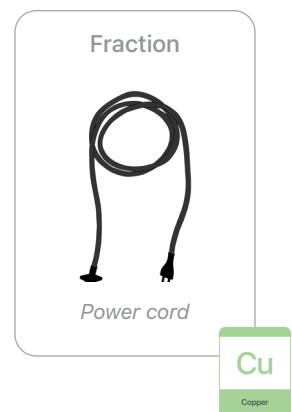

**Warning:** Before continuing disassembly, wait 10 minutes after unplugging the device for stored energy to discharge.



## 2. Unlock the housing.

- » *Lift the handle and turn it counterclockwise.*
- » *Pull the handle up and slide off the housing.*



- » *Set the assembly aside.*

### 3. Remove the power button.

» Turn the housing upside down.



Crushing hazard



Heavy weight hazard

» Detach the power button by unscrewing the four Torx T5 fasteners from inside the housing.

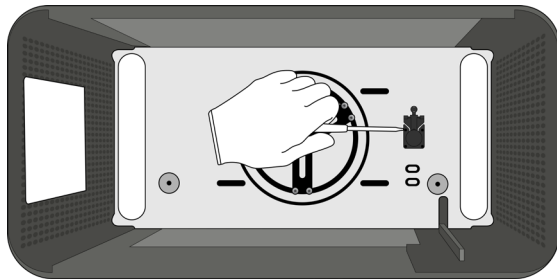

Tools Used



Fraction



Fasteners (x4)

Fe

Ferrous

Fraction

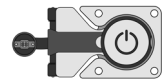

Power button

Cu

Copper

Fraction

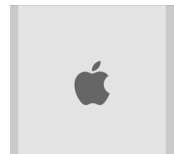

Housing

Al

Aluminum

## 4. From the assembly, remove the three clamp plates.

- » *On the right side, loosen the four Phillips captive fasteners from two clamp plates.*
- » *On the left side, loosen four more captive fasteners from the third clamp plate.*

### Tools Used

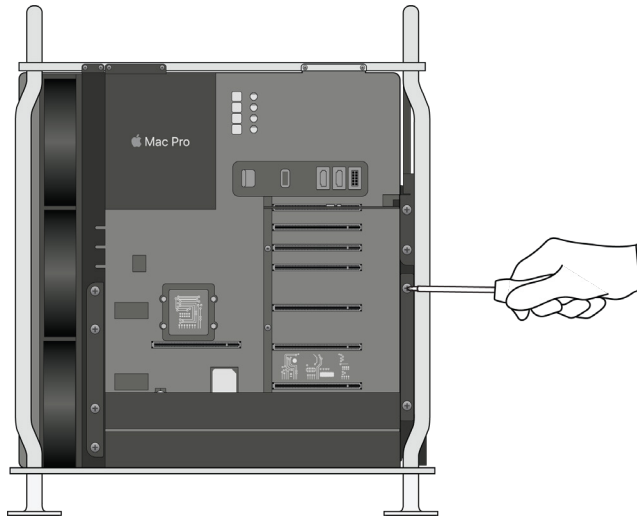
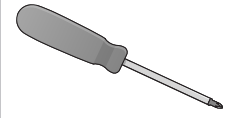

5. Pry the Phillips captive fasteners and springs off the three clamp plates.

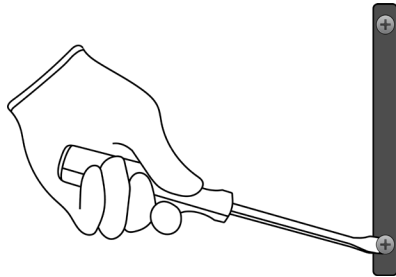

Tools Used

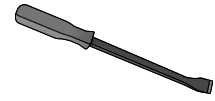

Fraction



Captive fasteners  
(x8)



Captive fastener  
springs (x8)

Fe

Ferrous

Fraction



Clamp plates

Al

Aluminum

## 6. Remove the I/O card.

» Slide the PCI lock to the unlocked position.

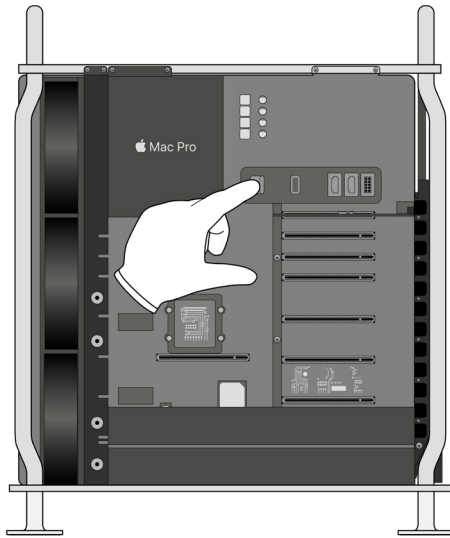

» Pull out the I/O card.

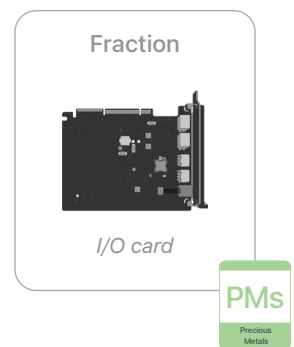
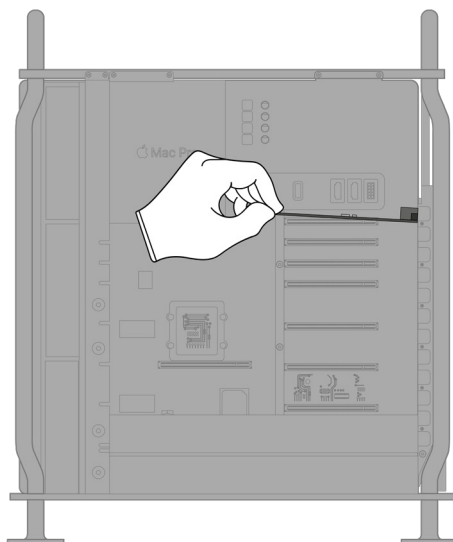

7. Using the ejector latch, slide the GPU off the main logic board.

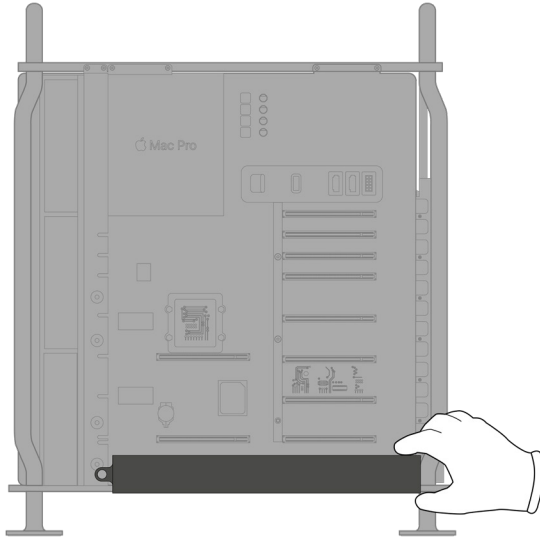

## 8. Disassemble the GPU.

» Peel off the Mylar film by hand.

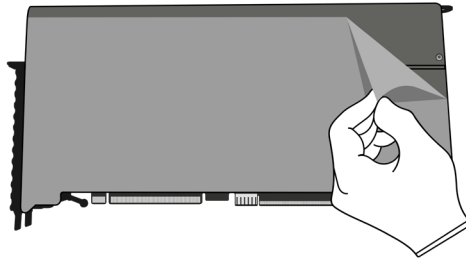

» Unscrew the one Torx T8 and five Torx T5 fasteners.

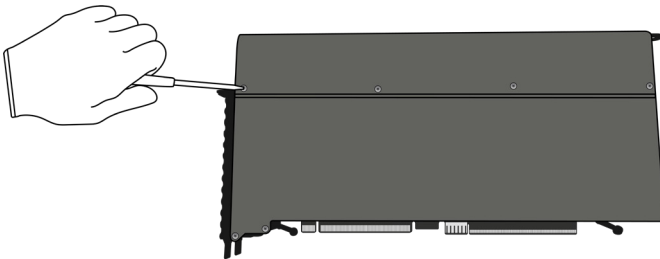

### Tools Used



Torx T8, Torx T5

### Fraction



Film

PL

Plastics

### Fraction



Fasteners (x6)

Fe

Ferrous

## 9. Remove the center bracket.

» Flip the GPU over. Unscrew the 10 Torx T8 fasteners.

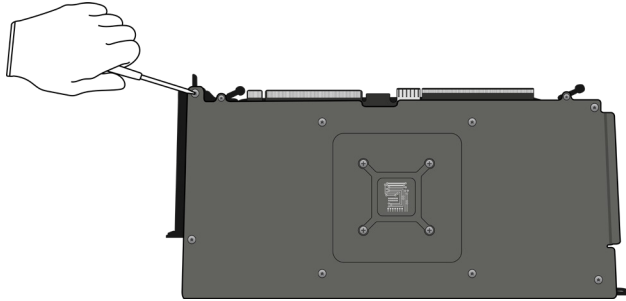

### Tools Used



Torx T8, Torx T5

» Unscrew the four Torx T5 fasteners. Pull off the center bracket by hand.

### Fraction



Fasteners (x14)

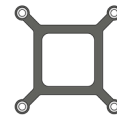

Center bracket

Fe

Ferrous



# 10. Remove the heat sink and GPU logic board.

» Pull off the front face of the GPU.

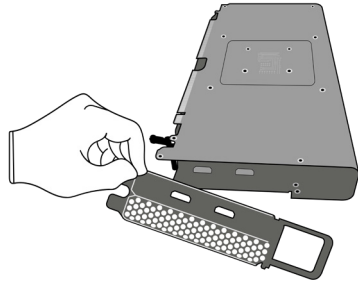

Fraction

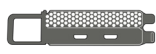

Front face

AI  
Aluminum

A diagram showing the front face of the GPU. It is a small, rectangular component with a perforated front. A line connects it to a green box containing the text 'AI' and 'Aluminum'.

» Separate the GPU housing from the heat sink.

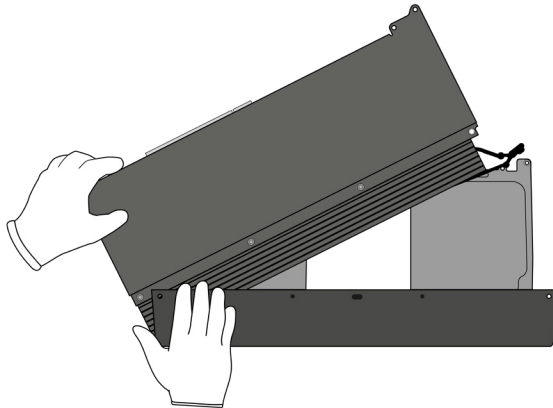

Fraction

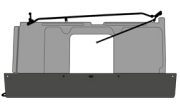

GPU housing

AI  
Aluminum

A diagram showing the GPU housing. It is a large, rectangular component with a perforated front. A line connects it to a green box containing the text 'AI' and 'Aluminum'.

» Pull the GPU logic board off the heat sink.

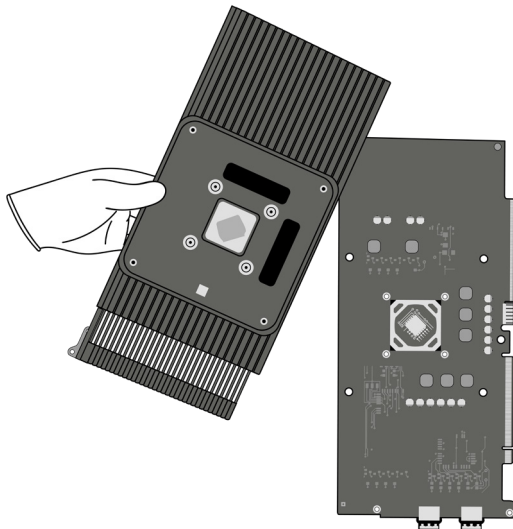

Fraction

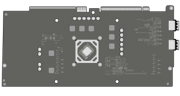

GPU logic board

PMs  
Precious Metals

A diagram showing the GPU logic board. It is a rectangular component with various electronic components. A line connects it to a green box containing the text 'PMs' and 'Precious Metals'.

Fraction

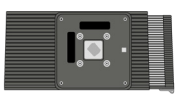

Heat sink

Cu  
Copper

A diagram showing the heat sink. It is a rectangular component with a perforated front. A line connects it to a green box containing the text 'Cu' and 'Copper'.

**11.** Remove the coin cell battery from the main logic board.

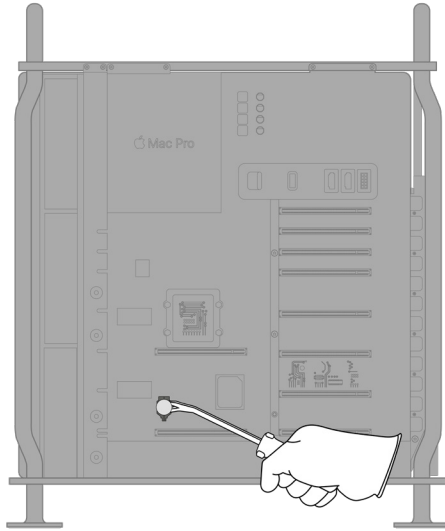

Tools Used

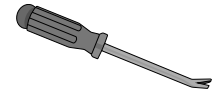

Fraction



Coin cell battery



## 12. Remove the power supply enclosure.

- » *Unscrew the one Torx T8 fastener. Slide out the enclosure.*

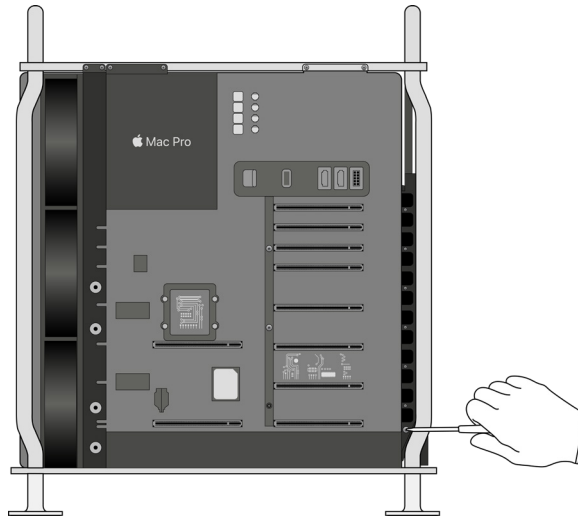

### Tools Used

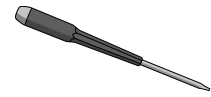

- » *Unscrew the 10 Torx T8 fasteners.*

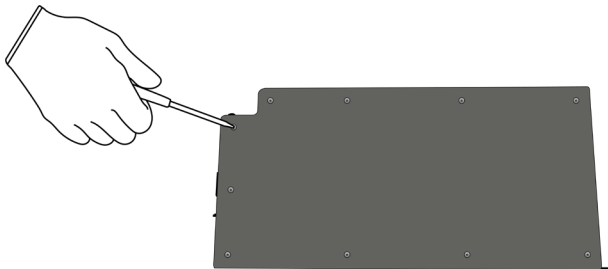

### Fraction



Fasteners (x11)

Fe

Ferrous

### 13. Remove the power supply logic board.

» Pry open the power supply enclosure by hand.



Sharp edges—cut hazard

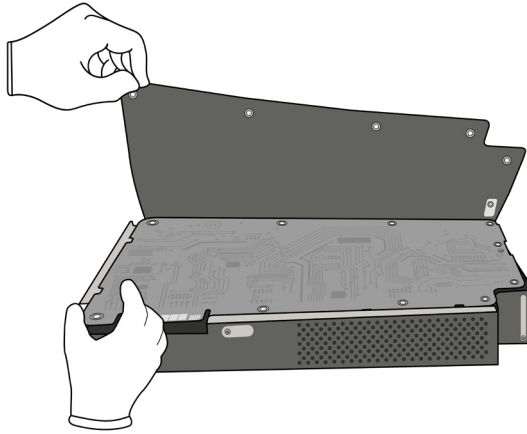

#### Tools Used

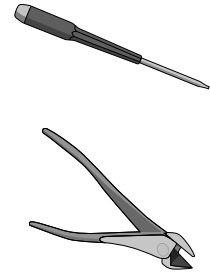

» Unscrew the one Torx T8 fastener from the power supply logic board.

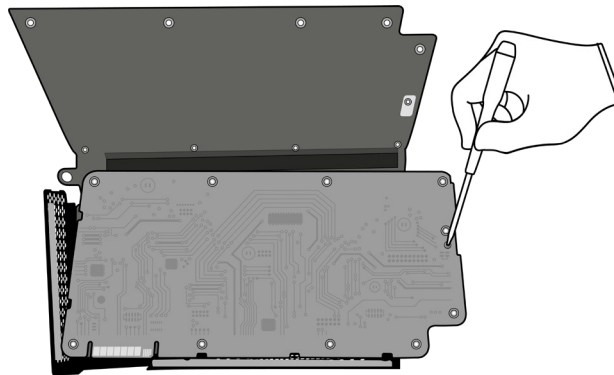

#### Fraction



Fastener

Fe

Ferrous

- » *Separate the power supply logic board from its enclosure by cutting the wires.*

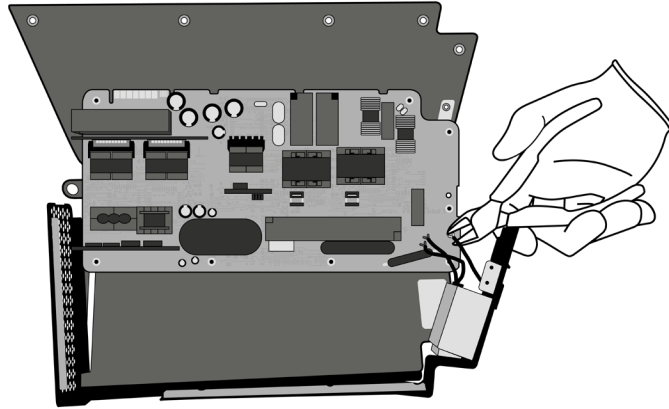

Fraction

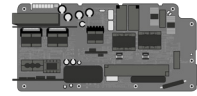

*Power supply  
logic board*

PMs  
Precious  
Metals

14. From the enclosure, remove the power adapter by unscrewing the one Torx T8 fastener.

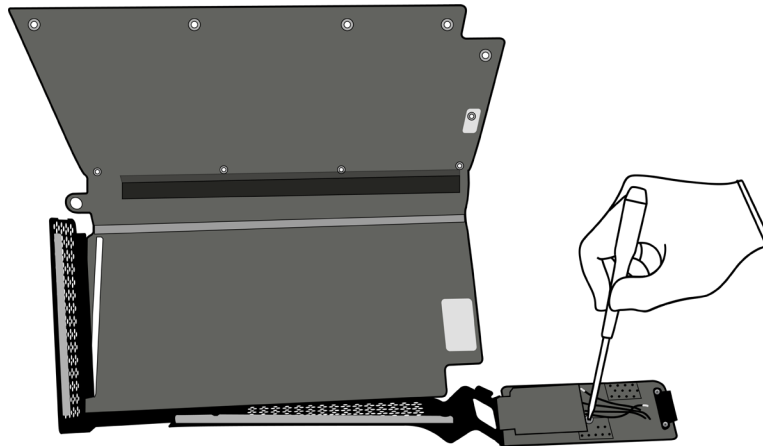

Tools Used

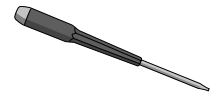

Fraction



Fastener

Fe

Ferrous

Fraction



Power adapter

Cu

Copper

Fraction



Power supply enclosure

Al

Aluminum

**15.** Remove both memory module covers.

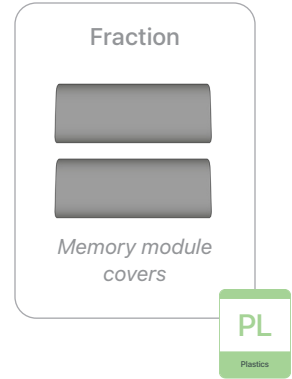
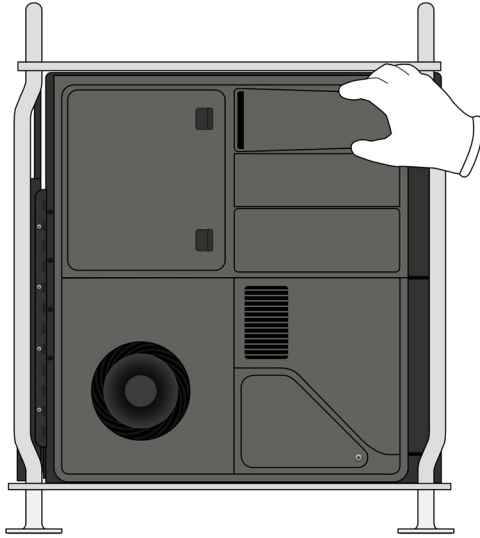

## 16. Remove the memory modules.

» Unlatch the memory modules by pushing the memory module ejectors.

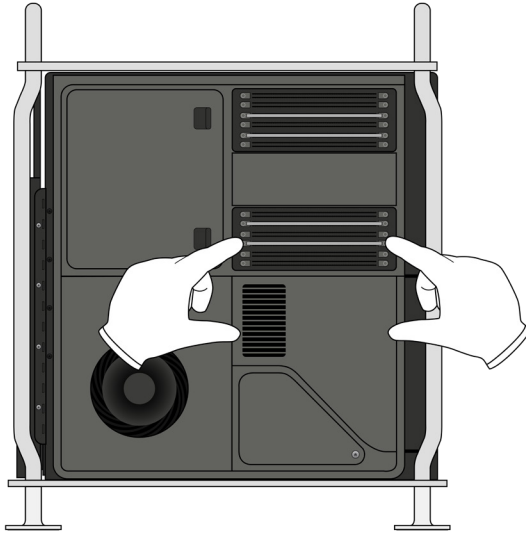

» Pull out the four memory modules.

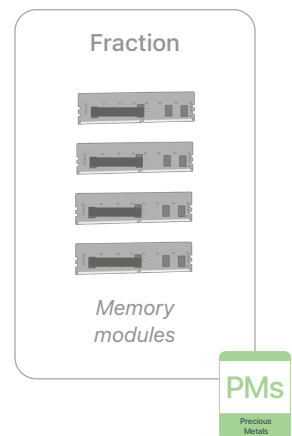
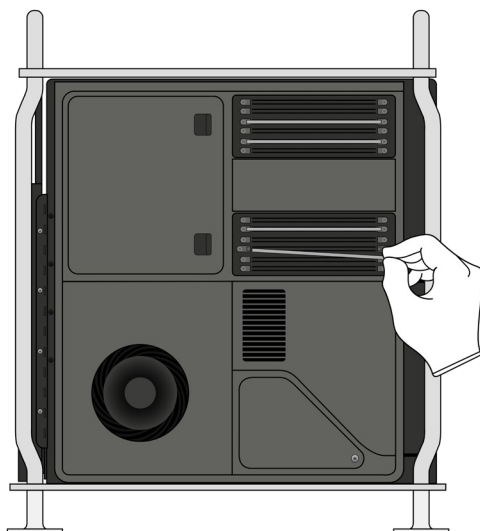



## 17. Remove the speaker.

» Slide the speaker to the left and tilt it forward.

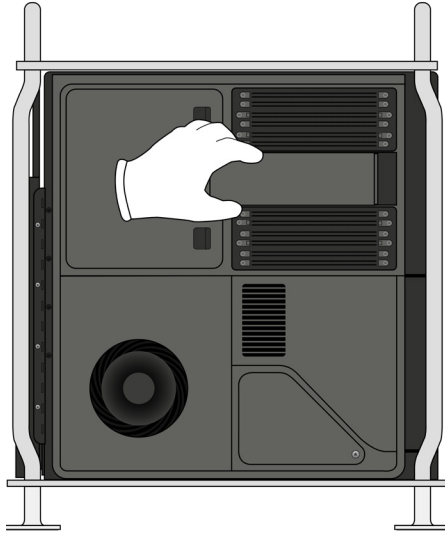

» Disconnect the speaker wire from the main logic board.

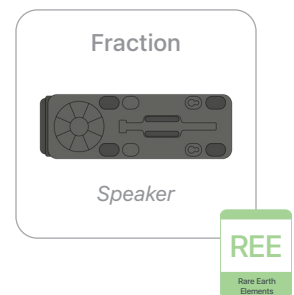
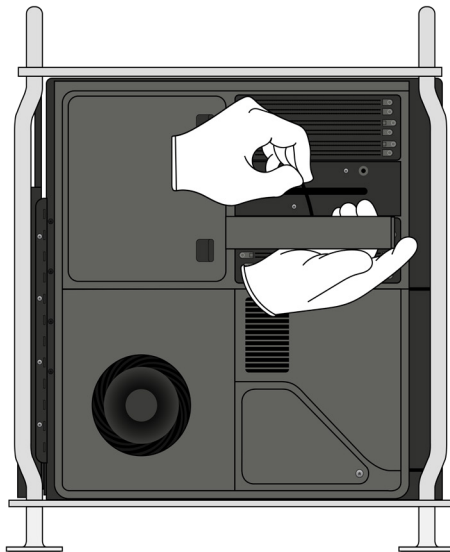

## 18. Remove the thermal module.

» Unscrew the four Torx T15 fasteners and springs.

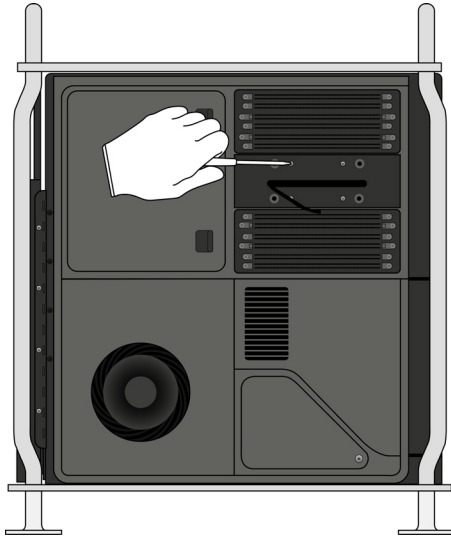

### Tools Used



Torx T15, Torx T8

### Fraction

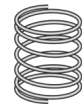

Springs (x4)

Fe

Ferrous

» Flip the assembly around. Unscrew the two Torx T8 fasteners from the thermal module.

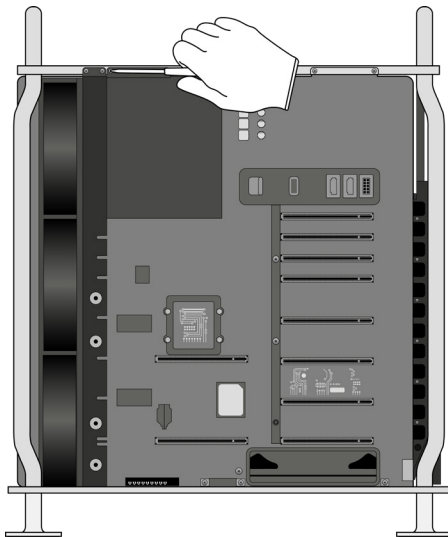

### Fraction



Fasteners (x6)

Fe

Ferrous

» Slide the thermal module off the assembly. Lay it facedown to expose the processor.

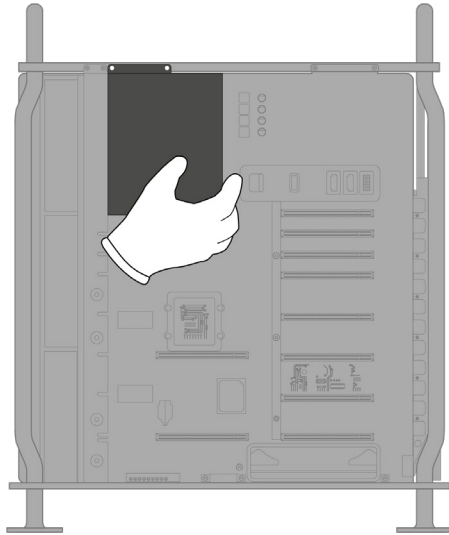

**19.** Lift the processor out of the thermal module.

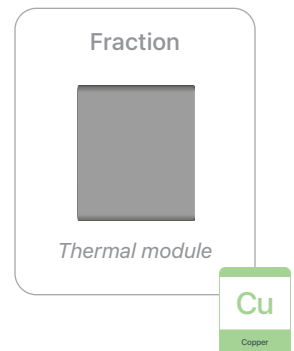
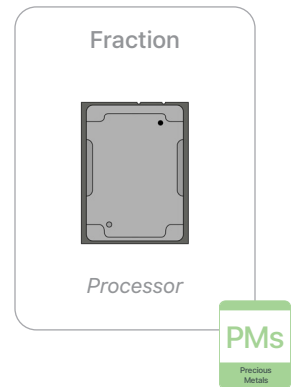
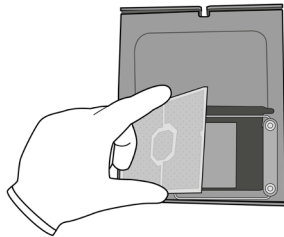

## 20. Remove the duct and blower.

- » *Loosen the three Torx T8 captive fasteners from the main logic board.*

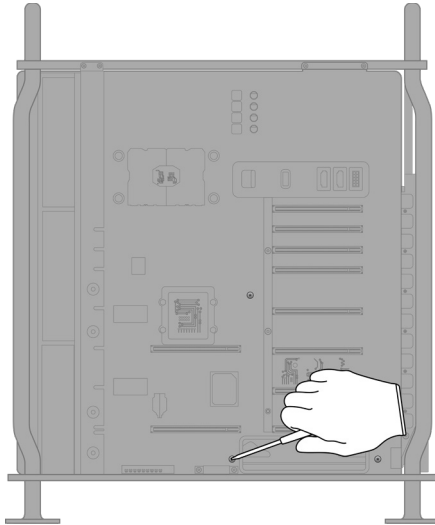

### Tools Used

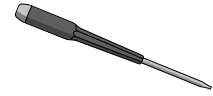

» Flip the assembly around and pull off the duct and the blower.

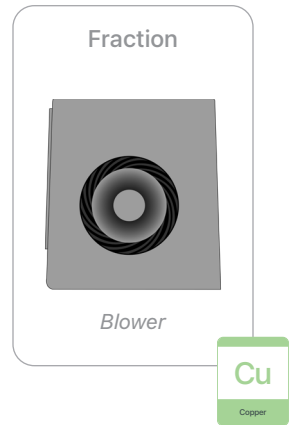
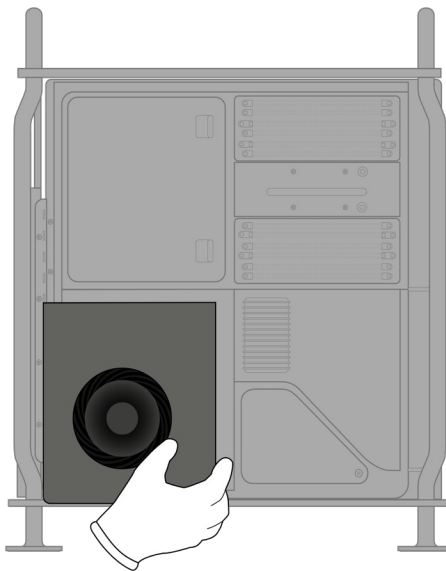
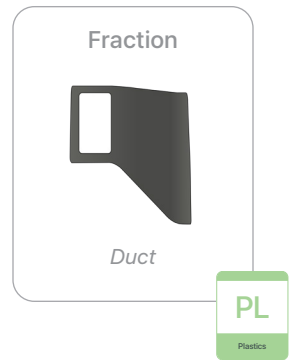
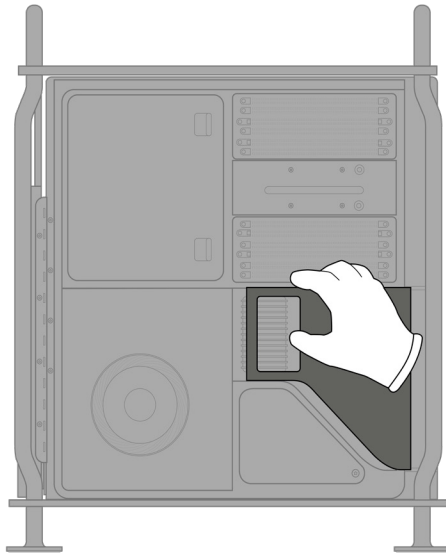

**21.** Remove the heat sink by unscrewing the four Torx T8 fasteners and springs.

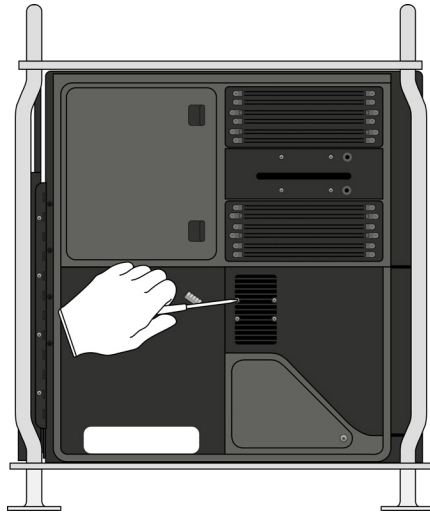

Tools Used

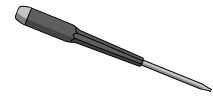

Fraction



Fasteners (x4)

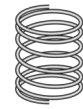

Springs (x4)

Fe

Ferrous

Fraction

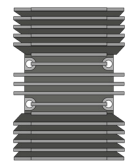

Heat sink

Al

Aluminum

## 22. Remove the system fans.

- » *Unscrew the three Torx T8 fasteners attached to the fans from the main logic board.*

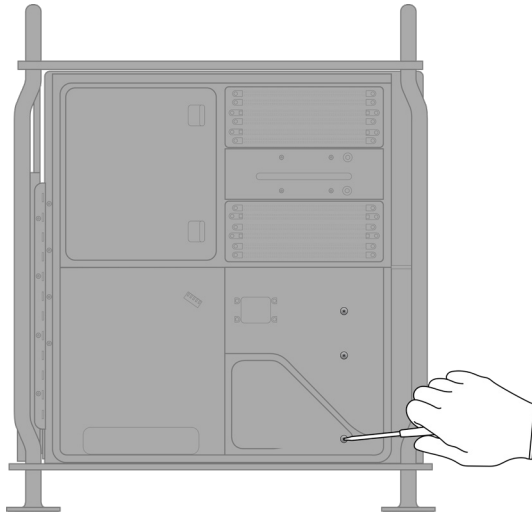

### Tools Used

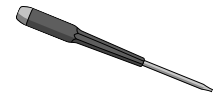

- » *Turn the assembly around. Unscrew the two Torx T8 fasteners from the top of the fans. Then unscrew the one Torx T8 fastener at the bottom.*

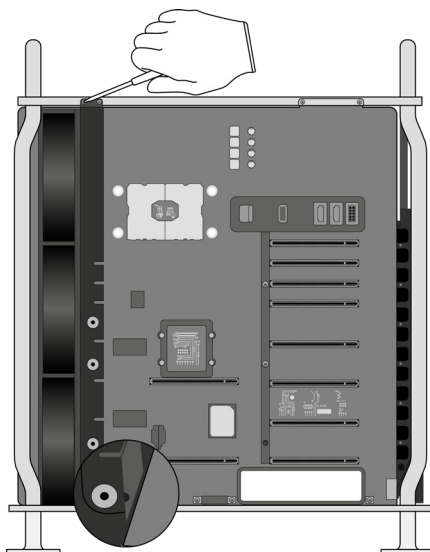

### Fraction



Fasteners (x6)

Fe

Ferrous

» Pull out the system fans.

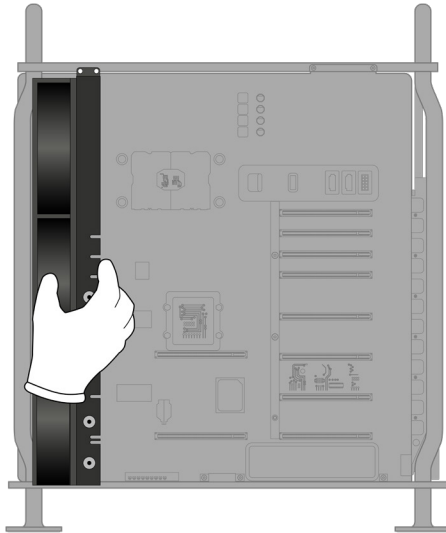

**23.** Unscrew the 12 Torx T8 fasteners from the system fans.

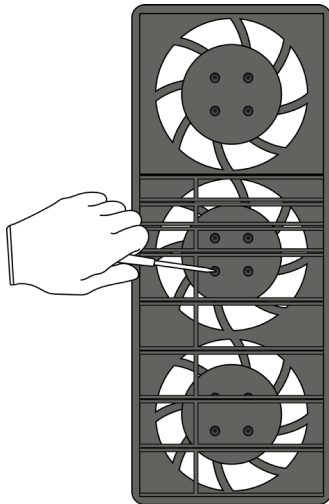

Tools Used

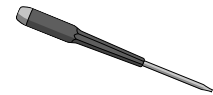

Fraction



Fasteners (x12)

Fe

Ferrous



## 24. Remove each fan.

» *Flip the system fans over and lift them out.*

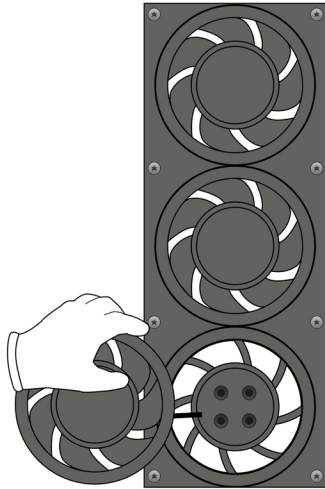

» *Disconnect the ribbon cable from behind each fan. Set the fans aside.*

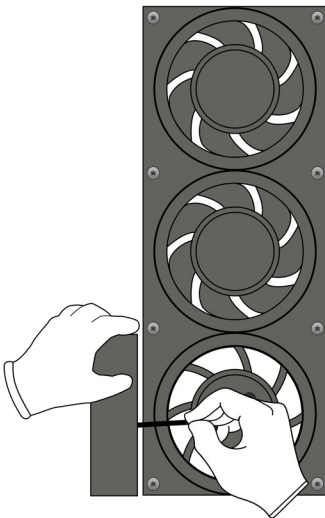

- 25.** Unscrew the eight Torx T8 fasteners from the fan enclosure. Lift up the top piece.

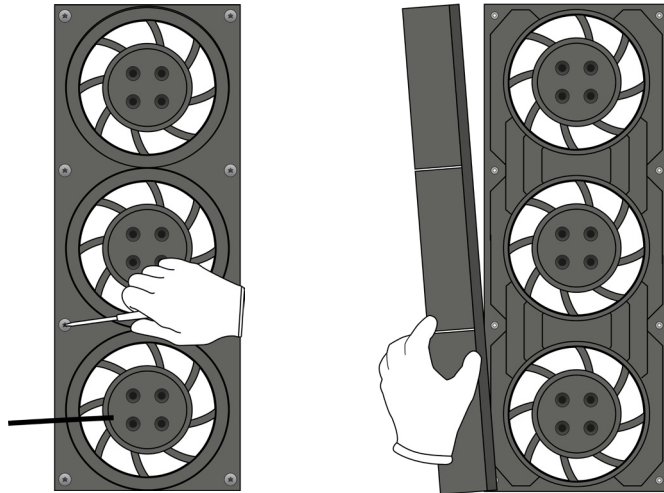

Tools Used

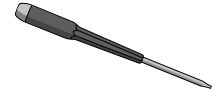

Fraction



Fasteners (x8)

Fe

Ferrous

- 26.** Remove the three ribbon cables from the fan enclosure.

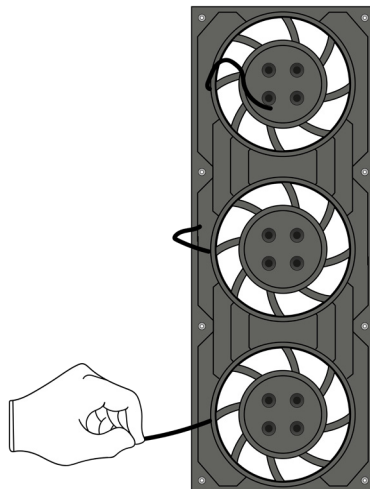

Fraction



Ribbon cables

Cu

Copper

Fraction

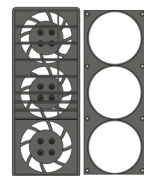

Fan enclosure

PL

Plastics

**27.** Pry the motor off each fan.

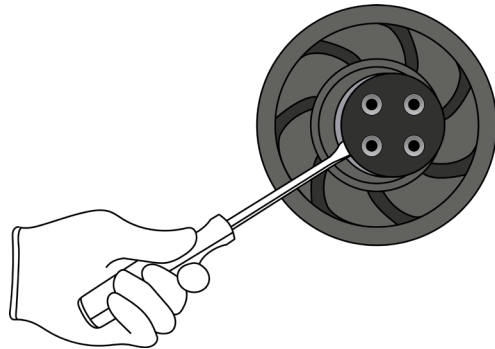

Tools Used



Fraction



Motors

Cu

Copper

Fraction



Fans

PL

Plastics

**28.** Remove the nine PCI Express slot covers.

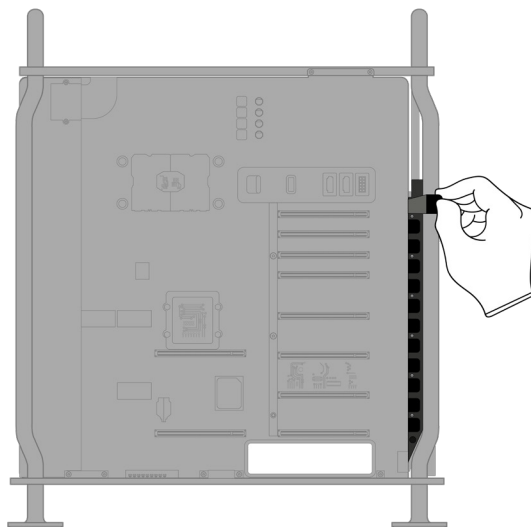

Fraction

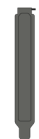

PCI Express slot covers (x9)

Al

Aluminum

## 29. Remove the I/O board flex cable.

- » Remove the flex cable cover by unscrewing the two Torx T5 fasteners.

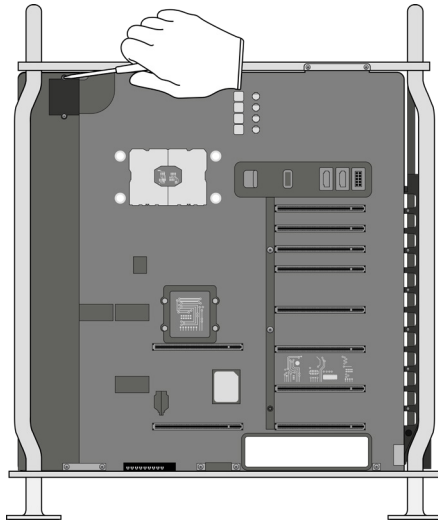

### Tools Used

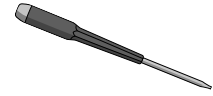

### Fraction



Fasteners (x2)

Fe

Ferrous

### Fraction

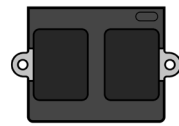

Flex cable cover

Al

Aluminium

» Remove the I/O board flex cable by hand.

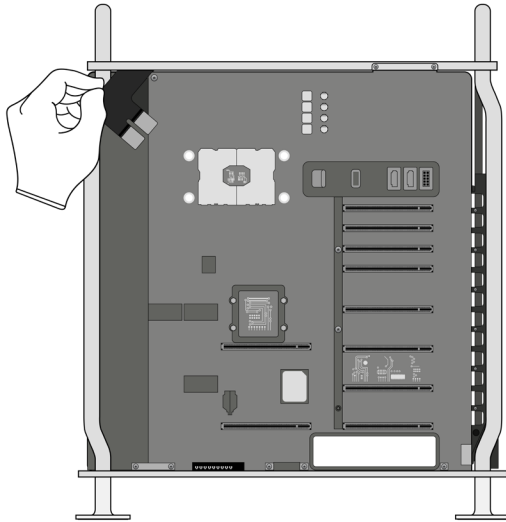

Fraction



I/O board flex cable

Cu  
Copper

A diagram showing the L-shaped I/O board flex cable component. Below the component is a green box containing the chemical symbol 'Cu' and the word 'Copper'.

### 30. Remove the I/O board.

- » Access the I/O board by unscrewing the one Torx T8 fastener with washer.

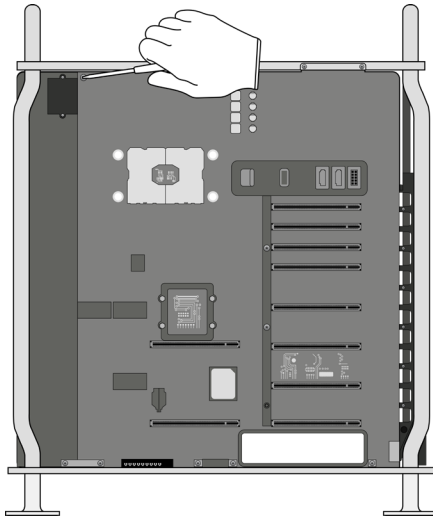

#### Tools Used

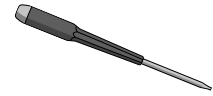

#### Fraction



Fastener



Washer

Fe

Ferrous

» Unscrew the six Torx T8 fasteners from around the I/O board.

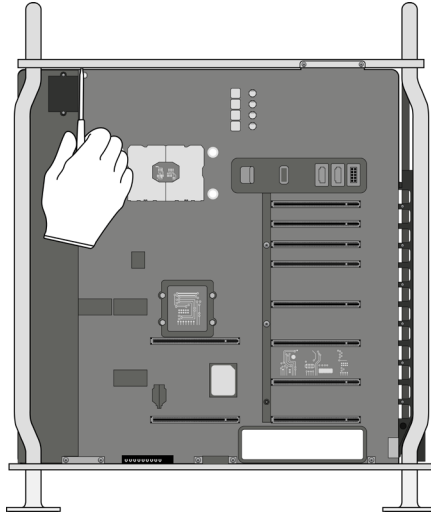

Fraction



Fasteners (x6)

**Fe**  
Ferrous

A diagram showing a Torx T8 fastener. Below it, the text "Fasteners (x6)" is displayed. To the right, a green box contains the chemical symbol "Fe" and the word "Ferrous".

» Remove the I/O board by hand.

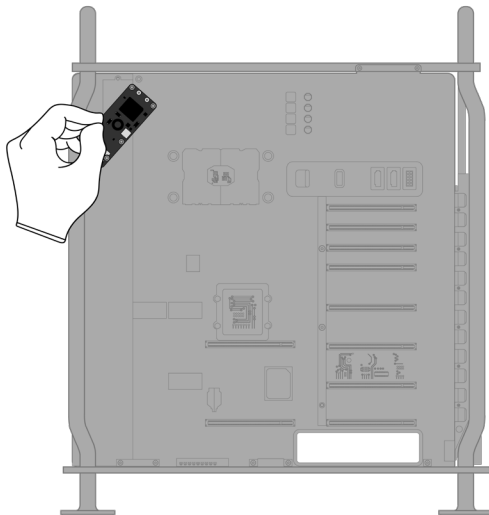

Fraction



I/O board

**PMs**  
Precious Metals

A diagram showing the I/O board. Below it, the text "I/O board" is displayed. To the right, a green box contains the chemical symbol "PMs" and the words "Precious Metals".

## 31. Remove the main logic board from its frame.

- » Unscrew the five Torx T8 fasteners from the bottom of the logic board.

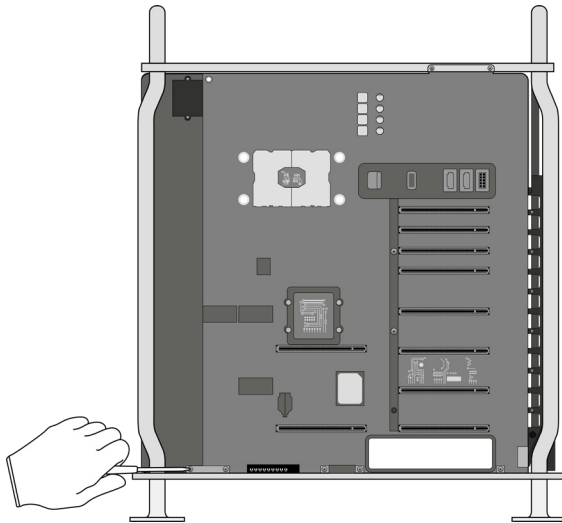

### Tools Used



- » Turn the frame to the back. Unscrew the four Torx T8 fasteners from the top of the logic board.

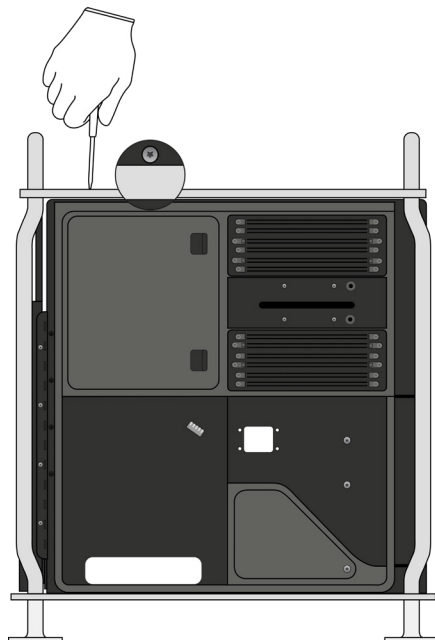

### Fraction



Fasteners (x9)

Fe

Ferrous



» Unscrew the other four Torx T8 fasteners along the left side.

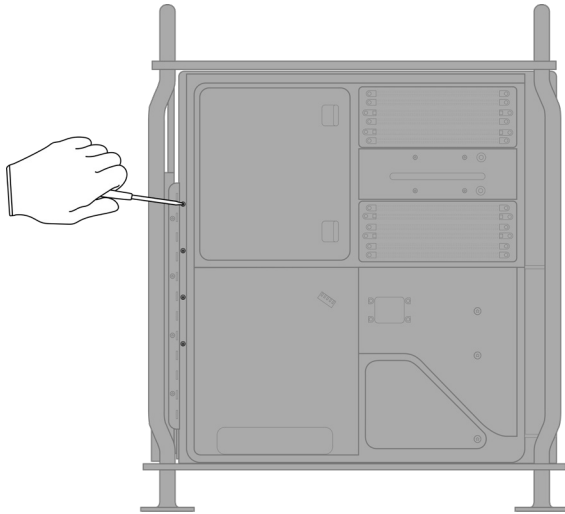

Fraction



Fasteners (x4)

Fe  
Ferrous

A callout box containing a Torx T8 fastener icon, the text "Fasteners (x4)", and a green box with the chemical symbol "Fe" and the word "Ferrous" below it.

» Slide the main logic board out of its frame. Set the frame aside.

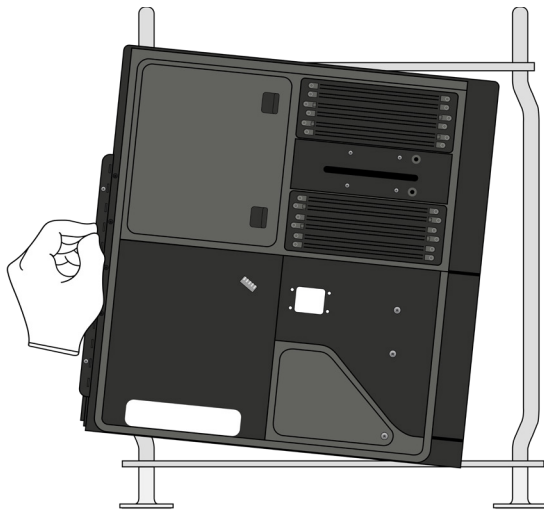

## 32. Remove the heat sink from the main logic board.

» Unscrew the four Torx T8 fasteners along the length of the heat sink.

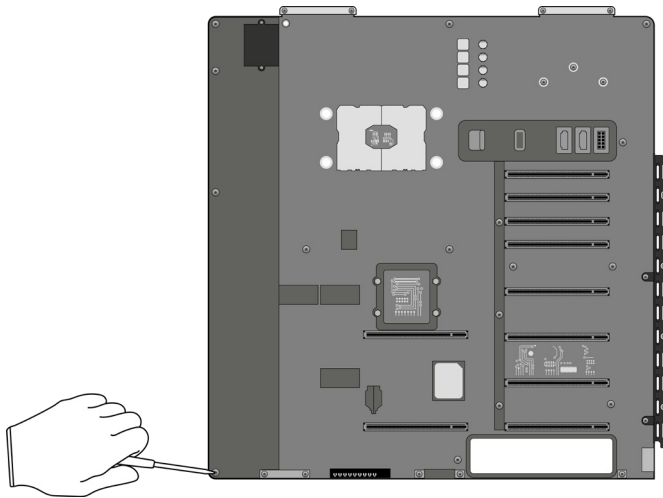

### Tools Used

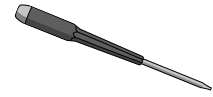

### Fraction



Fasteners (x4)

Fe

Ferrous

» By hand, pull the heat sink away from the logic board.

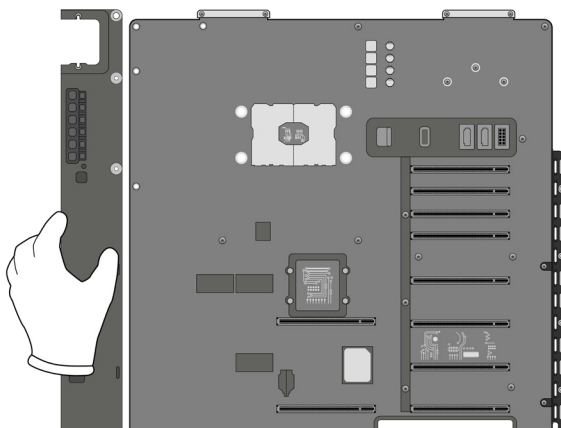

### Fraction



Heat sink

Al

Aluminum

### 33. Remove the side metal bracket.

» Unscrew the two Torx T8 fasteners.

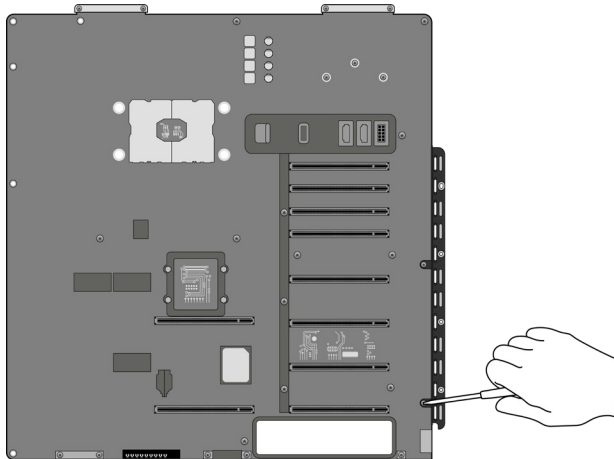

Tools Used

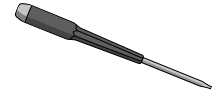

Fraction



Fasteners (x2)

Fe

Ferrous

» Pull off the metal bracket.

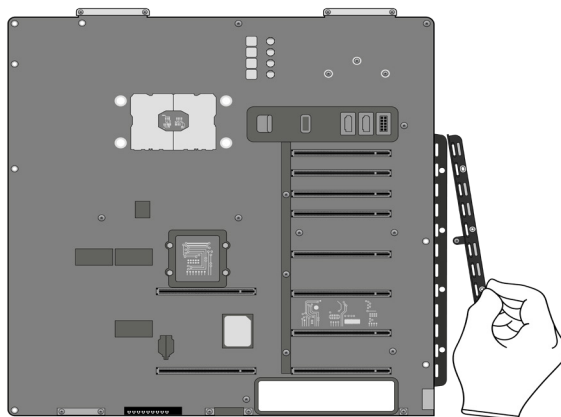

Fraction



Bracket

Al

Aluminum

### 34. Unscrew the 10 Torx T8 fasteners from the main logic board.

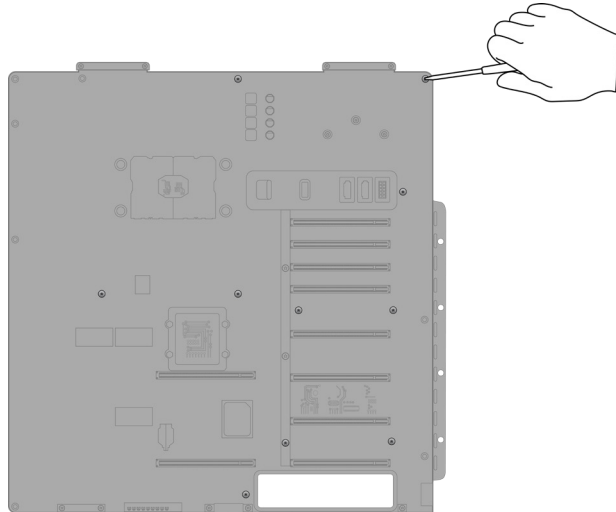

Tools Used

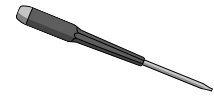

Fraction



Fasteners (x10)

Fe

Ferrous

### 35. Remove the aluminum back plate.

» Unscrew the three Torx T8 fasteners from the top right corner.

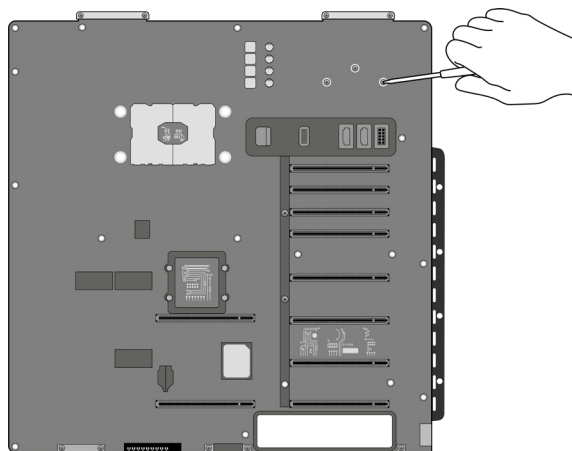

Tools Used

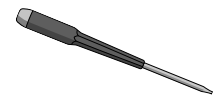

Fraction



Fasteners (x3)

Fe

Ferrous

» Flip the main logic board to the back. By hand, separate the back plate from the logic board.

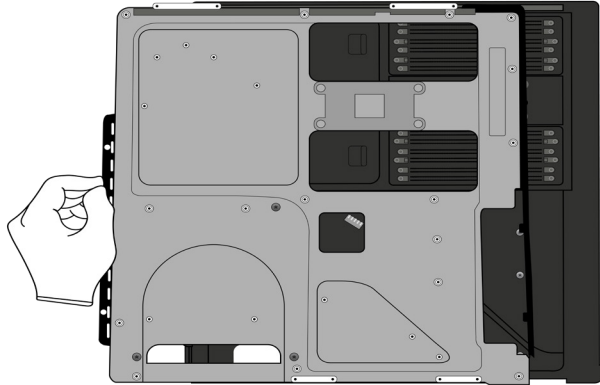

» Remove the plastic cover from the back plate.

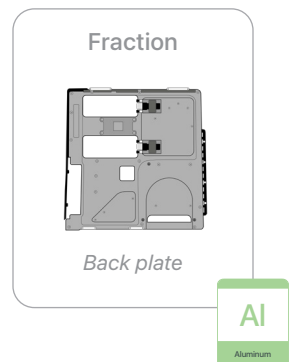
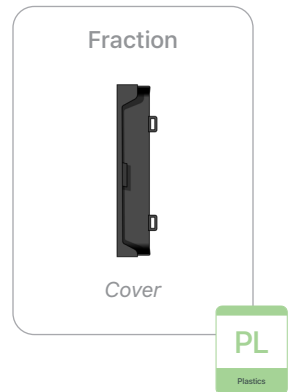
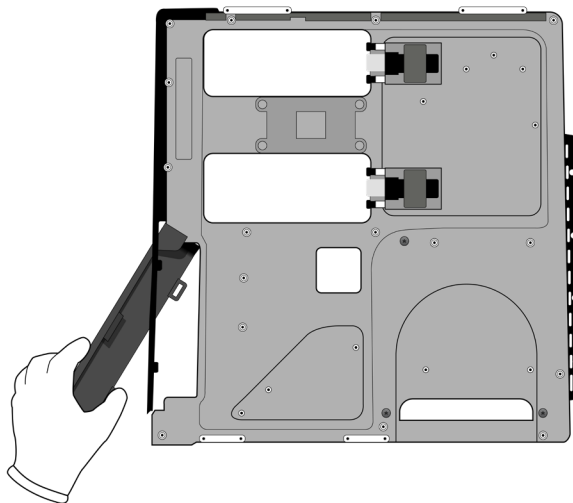

**36.** Remove the plastic gasket from the main logic board.

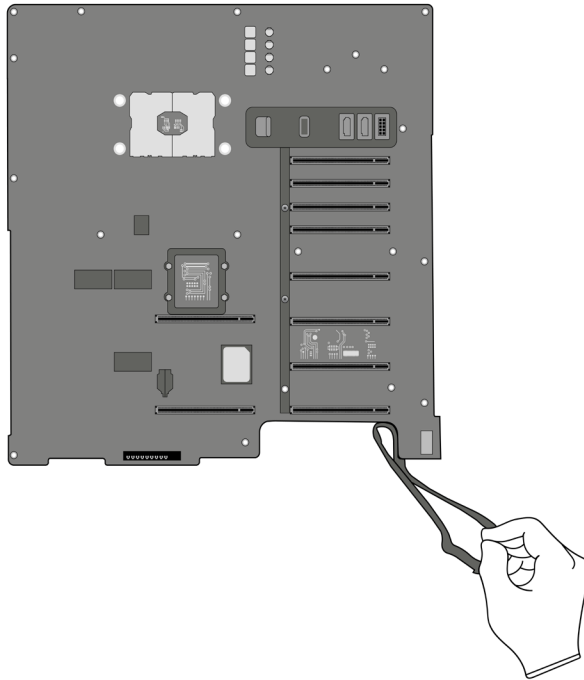

Fraction

Gasket

PL

Plastics

Fraction

Main logic board

PMs

Precious Metals

**37.** Unscrew the six Torx T5 fasteners that hold the cable brackets to the top plate.

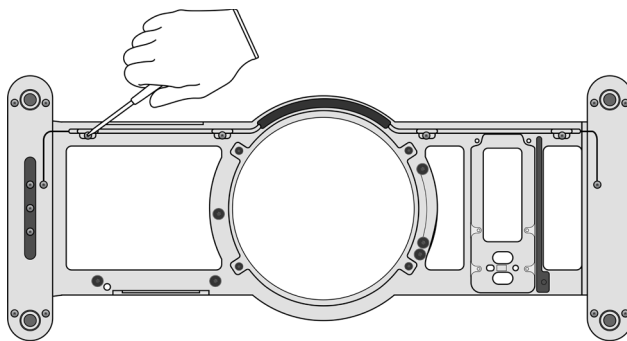

Tools Used

Fraction

Fasteners (x6)

Fe

Ferrous

**38.** Remove the PCI Express slots frame by unscrewing the three Torx T8 fasteners.

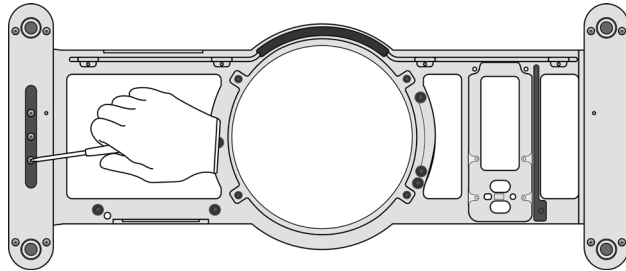

Tools Used

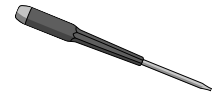

Fraction



Fasteners (x3)

Fe

Ferrous

Fraction



PCI Express  
slots frame

Al

Aluminum

**39.** Loosen the top plate by unscrewing the eight Torx T8 fasteners.

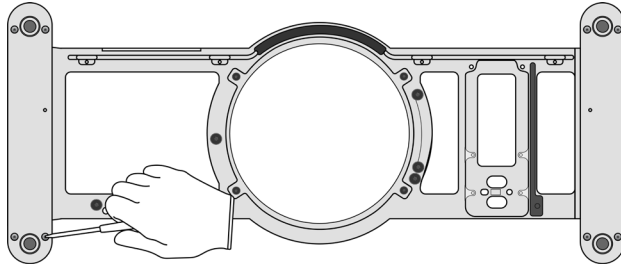

Tools Used

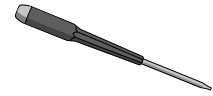

Fraction



Fasteners (x8)

Fe

Ferrous

**40.** Pry off both antennas from between the plates.

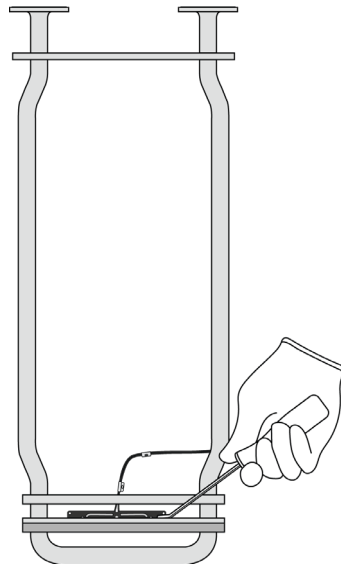

Tools Used



Fraction



Antennas

Cu

Copper



## 41. Remove the bottom plate.

- » *Lay the frame on its side.*
- » *Unscrew the four feet.*

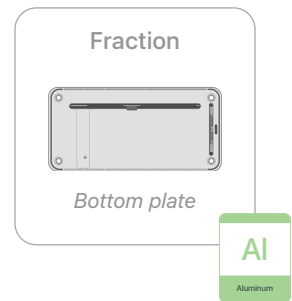
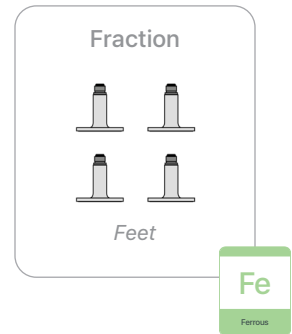
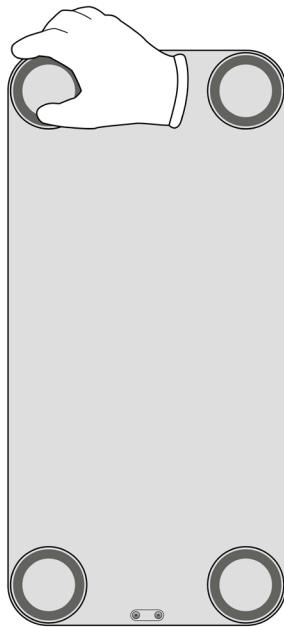

## 42. Remove the handles and antenna housing.

- » Set the frame upside down on the handles with the legs pointing straight up. Loosen the socket captive fasteners, two for each handle.

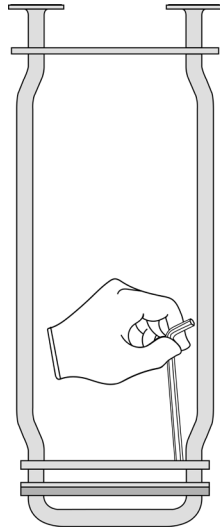

### Tools Used



- » Separate the handles from the antenna housing.

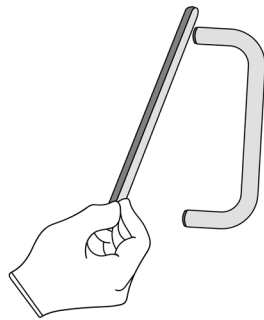

### Fraction



Handles

Fe

Ferrous

### Fraction



Antenna housing

Al

Aluminum





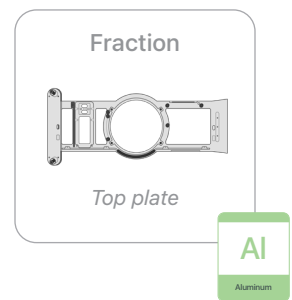
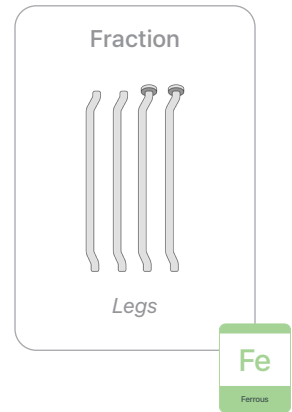
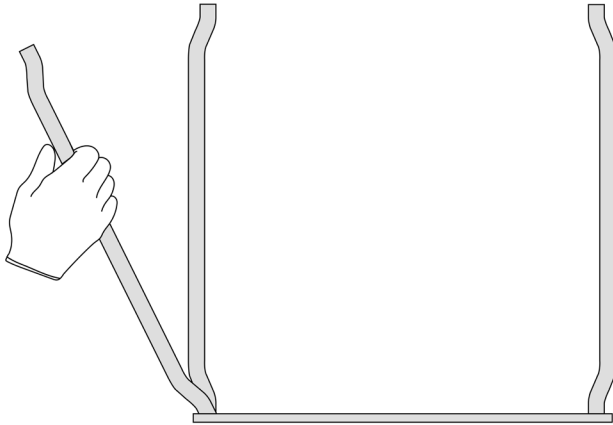

### 43. Remove the four legs.

- » Lay the frame on its side.
- » Move each leg back and forth until it separates from the top plate.

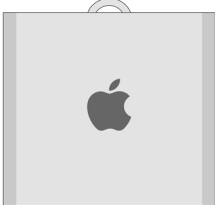

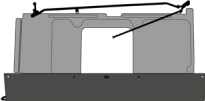
# Material Categorization of Output Fractions

All outputs from this process must be managed, handled, and disposed of in accordance with applicable waste laws and regulations, including but not limited to the Waste Framework Directive and its national enactments in Europe.

Fraction	Downstream Processing
<p data-bbox="435 554 570 579"><b>Aluminum</b></p>  <p data-bbox="459 846 542 867"><i>Housing</i></p>  <p data-bbox="440 1131 565 1152"><i>Clamp plates</i></p>  <p data-bbox="451 1274 553 1295"><i>Front face</i></p>  <p data-bbox="440 1467 561 1488"><i>GPU housing</i></p>  <p data-bbox="388 1709 620 1730"><i>Power supply enclosure</i></p>	<p data-bbox="964 554 1276 579"><b>Primary Target Material</b></p>  <p data-bbox="924 806 1317 831"><b>Potential Additional Materials</b></p> 

Aluminum (cont.)

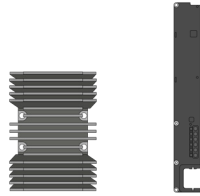

Heat sinks

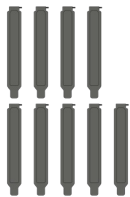

PCI Express slot covers



I/O board flex cable cover



Bracket

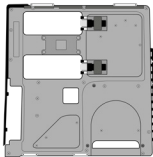

Back plate

**Aluminum (cont.)**



*PCI Express slots frame*



*Bottom plate*



*Antenna housing*

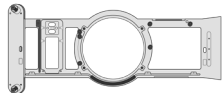

*Top plate*

---

**Batteries**



*Coin cell battery*

**Primary Target Material**



**Fraction**

**Downstream Processing**

**Ferrous**

**Primary Target Material**



*Captive fasteners (x8)*

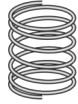

*Captive fastener springs (x8)*



*Fasteners (x131), springs (x8), and washer*

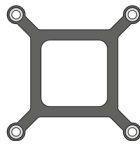

*Center bracket*

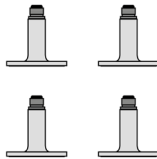

*Feet*



**Ferrous (cont.)**

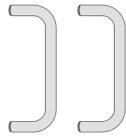

*Handles*

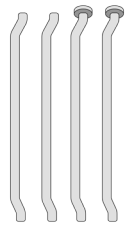

*Legs*

**Logic Boards**

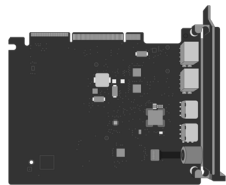

*I/O card*

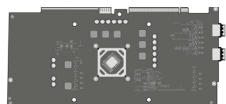

*GPU logic board*

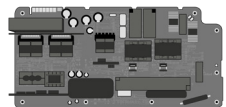

*Power supply logic board*

**Primary Target Material**



**Potential Additional Materials**





**Logic Boards (cont.)**

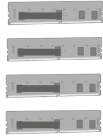

Memory modules

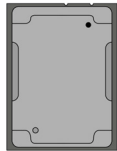

Processor



I/O board

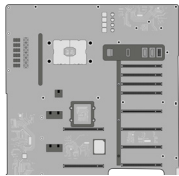

Main logic board

**Mixed Electronics**



Power cord

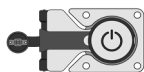

Power button

**Primary Target Material**



**Potential Additional Materials**



Mixed Electronics (cont.)

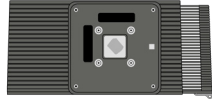

Heat sink



Power adapter



Thermal module



Blower



Ribbon cables



Fan motors



I/O board flex cable

Mixed Electronics (cont.)

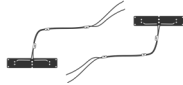

Antennas

Mixed Plastics



Mylar film



Memory module covers



Duct

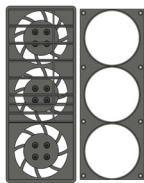

Fan enclosure

Primary Target Material



**Fraction**

**Downstream Processing**

**Mixed Plastics (cont.)**



*Fans*



*Cover*



*Gasket*

**Rare Earth Magnets**

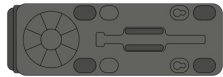

*Speaker*

**Primary Target Material**



**Potential Additional Materials**

