



Mac mini (2018)

Apple Recycler Guide

May 2023

Contents

3	About This Guide
4	Identification
5	Directive 2012/19/EU Annex VII Components
6	Safety Considerations
7	Recommended Tools
8	Disassembly Instructions
26	Material Categorization of Output Fractions

About This Guide

Apple Recycler Guides provide guidance for electronics recyclers on how to disassemble products to maximize recovery of resources. The guides provide step-by-step disassembly instructions and information on the material composition to help recyclers direct fractions to the appropriate material recycler.

To conserve important resources, we work to reduce the materials we use and aim to one day source only recycled or renewable materials in our products. A key path to reaching that goal is resource recovery from end-of-life electronics.

Disassembly procedures are intended to be performed only by trained electronics recycling professionals. The recycler is responsible for independently evaluating and ensuring compliance with all applicable environmental, health, and safety laws related to the work. These include but are not limited to laws relating to the management, handling, shipping, and disposal of the outputs of this work as waste and laws in place to ensure the health and safety of all employees who support this work.

For questions or feedback about this guide, email contactesci@apple.com.

Identification

You can find the model number printed on the underside of the Mac mini.



Model number:
A1993

Directive 2012/19/EU Annex VII Components

Directive 2012/19/EU Annex VII requirements apply to the following substances and components.

Substance/Component	Apple Part Name	Removal Instructions
Printed circuit board if the surface is greater than 10 square centimeters	Main logic board, memory modules, power supply logic board	Follow steps 1–15
External electric cables	Power cord	Follow step 1
Battery	Coin cell battery	Follow steps 1–6
No further substances or components as listed in Annex VII		

Safety Considerations

The recycler is responsible for independently evaluating all activities undertaken by its employees to perform or support the work and ensuring compliance with all applicable health and safety laws related to the work. These include but are not limited to laws relating to the health and safety of all employees who perform or support this work. The recycler is also responsible for evaluating the workspace and ensuring that the area in which the work is to be undertaken is designed using ergonomic best practices and meets all ergonomic requirements to ensure the protection of its employees.

Personal Protective Equipment

Personal protective equipment should be worn during the entire recycling process.



Wear hand protection



Wear protective clothing



Wear eye protection



Wear foot protection

Recommended Tools

Miniature pry bar

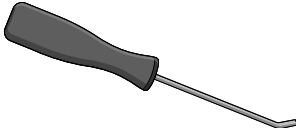

Nail-pulling screwdriver

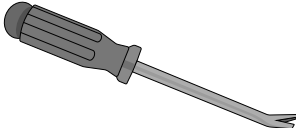

Torx T5 screwdriver

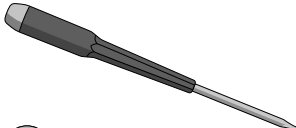

Torx TR6 screwdriver

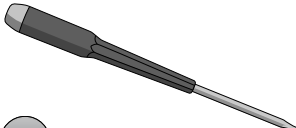

Torx T10 screwdriver

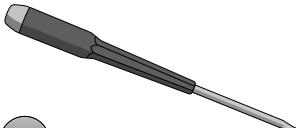

Wire cutters

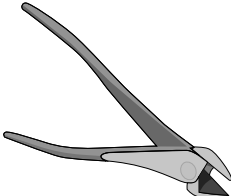

Disassembly Instructions

1. Remove the power cord.

» *Ensure that the Mac mini is turned off.*



» *Unplug and remove the power cord.*



Warning: Before continuing disassembly, wait 10 minutes after unplugging the device for stored energy to discharge.

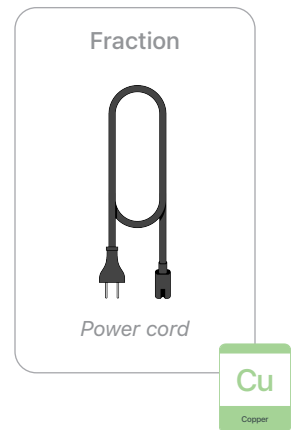

2. Remove the plastic dust cover, exposing the aluminum shield.

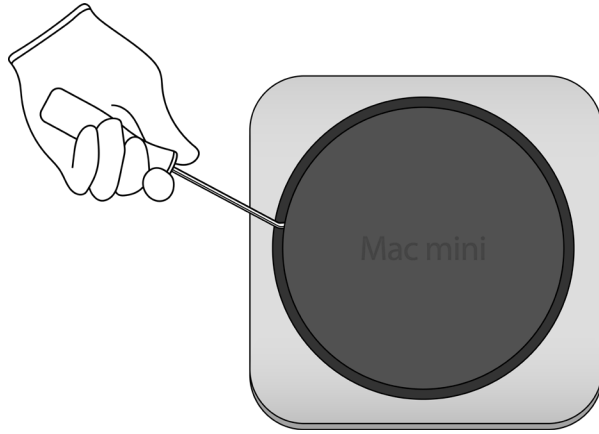

Tools Used



Fraction



Dust cover

PL

Plastics

- 3.** Remove the six Torx TR6 fasteners holding the aluminum shield to the enclosure. Lift off the aluminum shield and set the Mac mini aside.

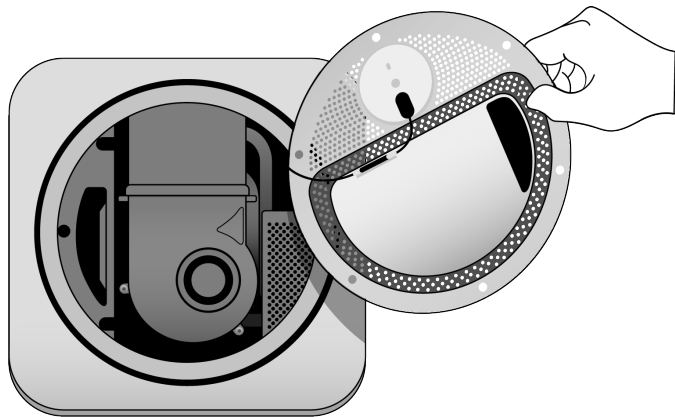
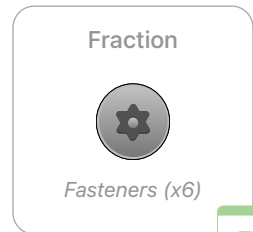
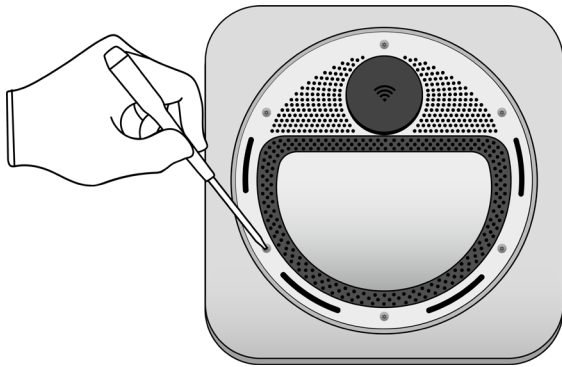

4. Pry off the Wi-Fi antenna from the aluminum shield.

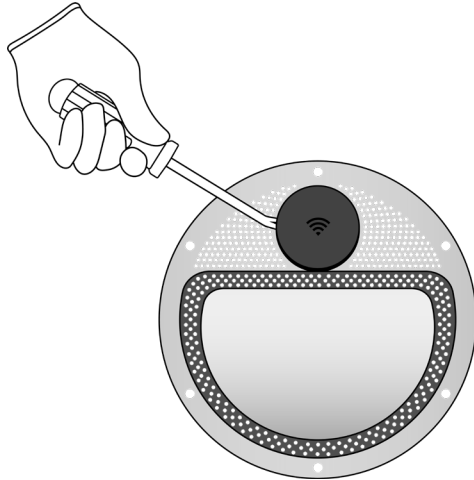

Tools Used

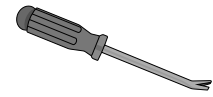

Fraction

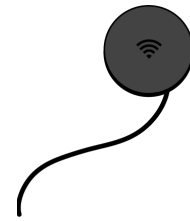

Wi-Fi antenna

Cu

Copper

Fraction



Shield

Al

Aluminum

5. Remove the fan.

- » Remove the four Torx TR6 fasteners holding the fan to the main logic board and heat sink.

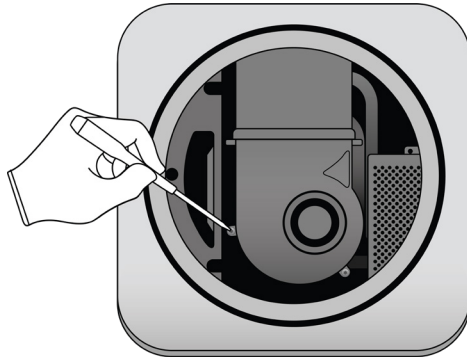

- » Lift out the fan to remove.

Tools Used

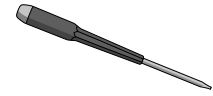

Fraction



Fasteners (x4)

Fe

Ferrous

Fraction

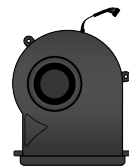

Fan

Cu

Copper

6. Remove the battery.

» Remove the battery bracket from the main logic board.

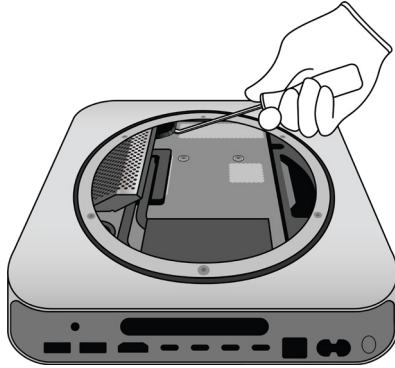

Tools Used



Fraction



Coin cell battery

BT

Battery

» Separate the coin cell battery from the bracket.

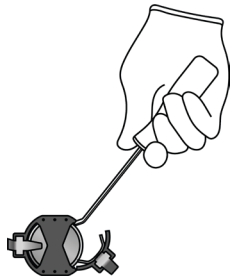

Fraction



Battery bracket

Cu

Copper

7. Remove the main logic board.

- » Remove the two Torx T10 screws holding the main logic board to the enclosure.

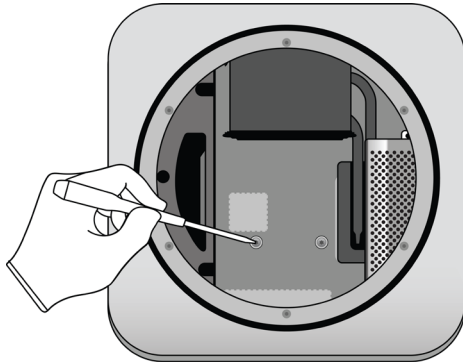

Tools Used

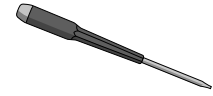

Fraction



Fasteners (x2)

Fe

Ferrous

- » Using both thumbs, push out the main logic board from the enclosure. Set the enclosure aside.

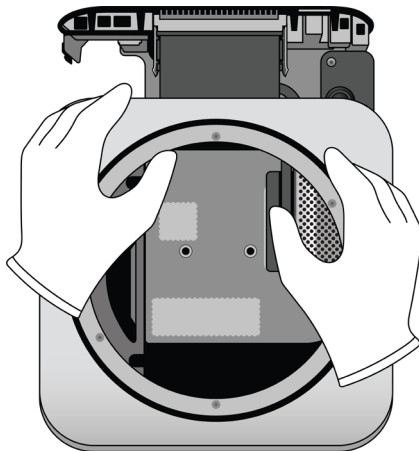

8. Pry up on the speaker to remove it from the main logic board.

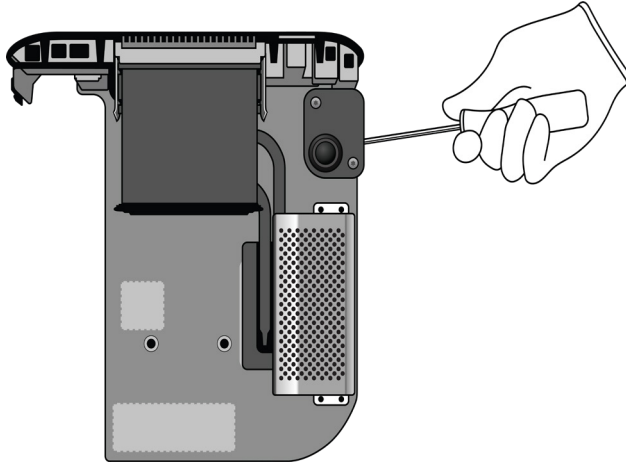

Tools Used



Fraction



Speaker



9. Remove the memory modules.

» Remove the four Torx T5 fasteners.

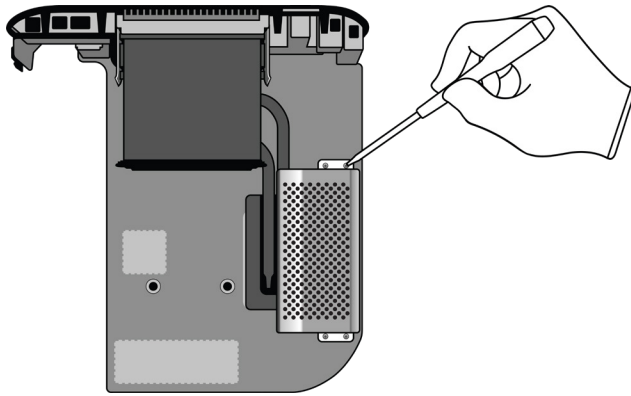

Tools Used

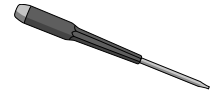

Fraction



Fasteners (x4)

Fe

Ferrous

» Lift off the heat shield to expose both memory modules.

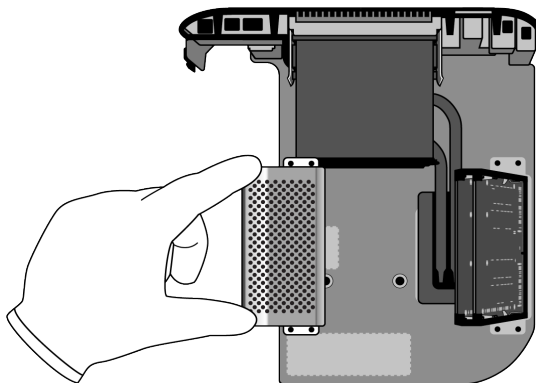

Fraction



Heat shield

Fe

Ferrous

» Lift up the memory modules to remove.

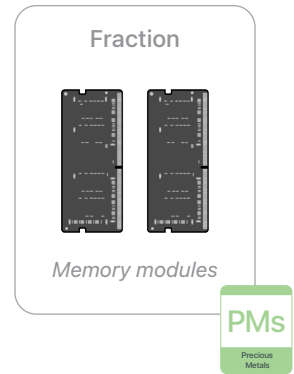
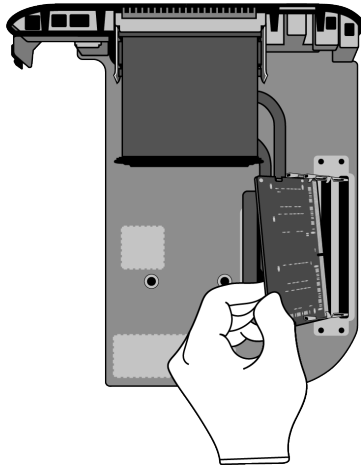

10. Remove the heat sink.

- » *Flip the main logic board over. Remove the eight Torx T5 fasteners.*

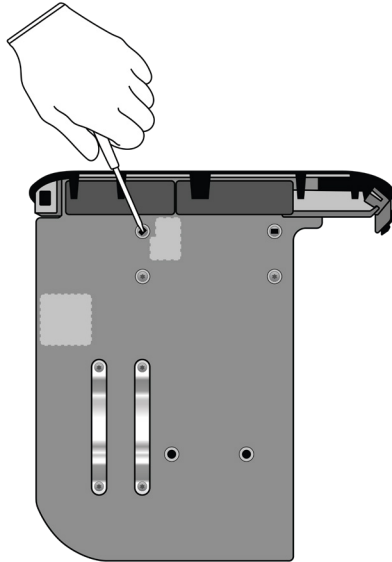

Tools Used

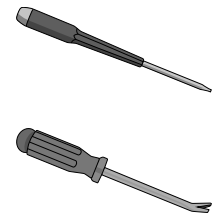

Fraction



Fasteners (x8)

Fe

Ferrous

- » *Remove the two mounting straps.*

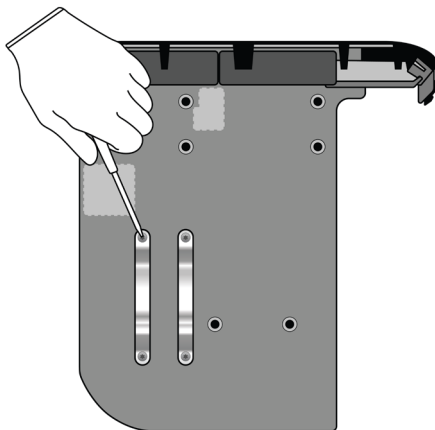

Fraction



Mounting straps

Fe

Ferrous

» Flip the main logic board over again. Remove the four Torx T5 fasteners.

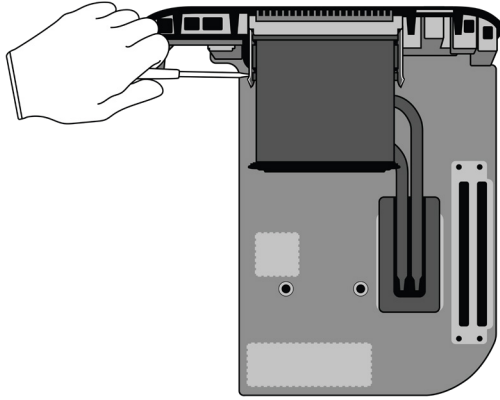

Fraction



Fasteners (x4)

Fe
Ferrous

A diagram showing a single Torx T5 fastener. Below it, the text "Fasteners (x4)" indicates the quantity. To the right is a green box with the chemical symbol "Fe" and the word "Ferrous" below it.

» Pry off the heat sink and heat sink channels.

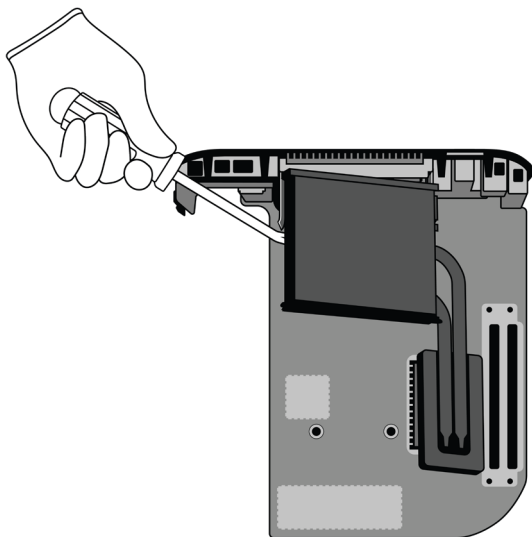

Fraction

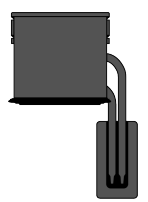

Heat sink and heat sink channels

Cu
Copper

A diagram showing the heat sink and heat sink channels. Below it, the text "Heat sink and heat sink channels" is present. To the right is a green box with the chemical symbol "Cu" and the word "Copper" below it.

11. Pull off the front face of the main logic board.

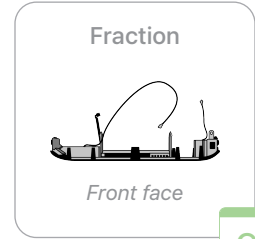
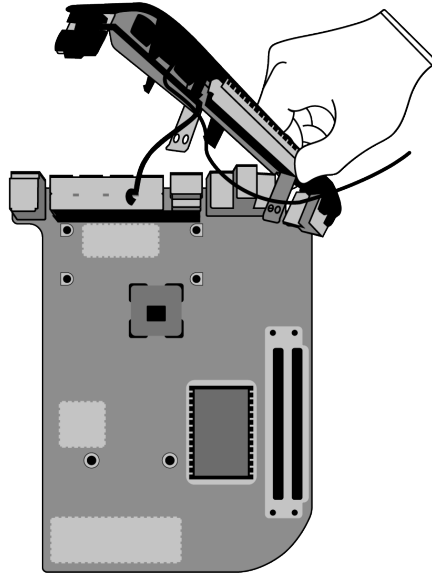

Cu
Copper

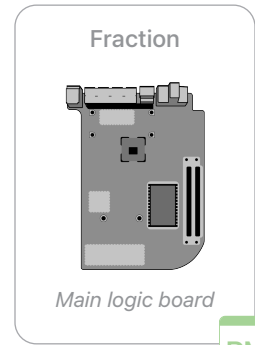

PMs
Precious Metals

12. Remove the power supply.

- » *Remove the three Torx TR6 fasteners from the power supply.*

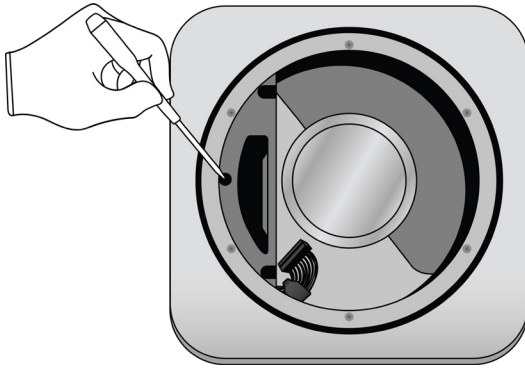

Tools Used

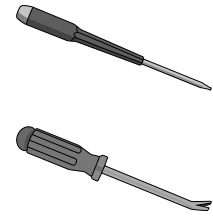

Fraction



Fasteners (x3)

Fe

Ferrous

- » *Pry the power supply away from the enclosure.*

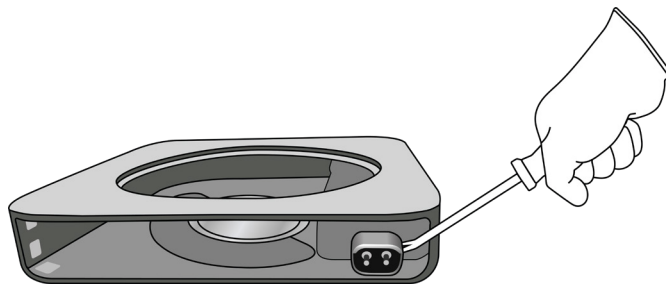

» Slide the power supply out of the enclosure.

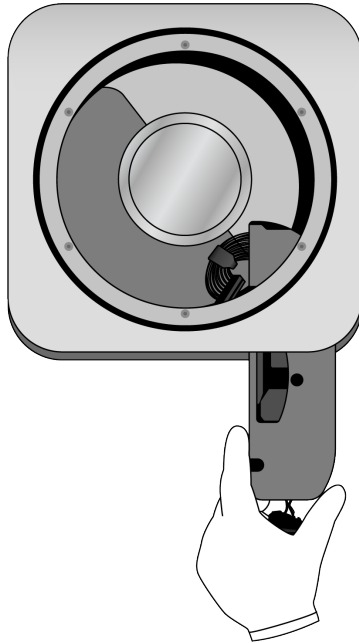

13. Remove the power adapter ring.

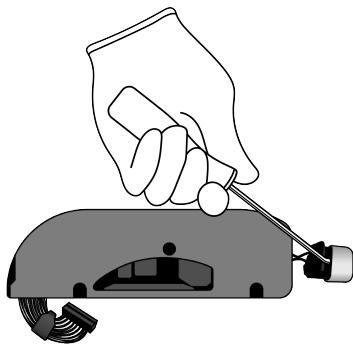

Tools Used



Fraction



Power adapter ring

Fe

Ferrous

14. Cut off the wires and adapter.

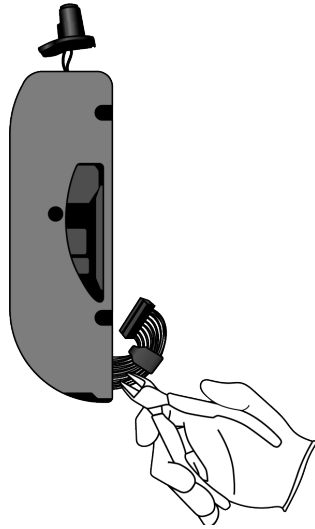

Tools Used

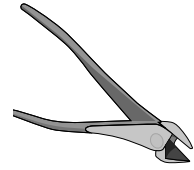

Fraction



Adapter



Wires

Cu

Copper

15. Pry off the plastic cover.

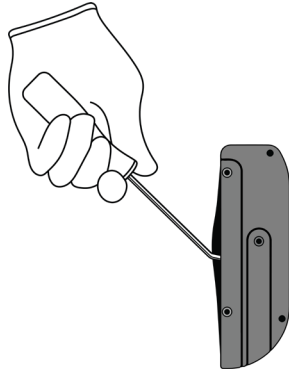

Tools Used



Fraction



*Power supply
logic board*

PMs

Precious
Metals

Fraction

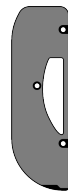

*Power supply
cover*

PL

Plastics

16. Pry off the Bluetooth antenna from inside the enclosure.

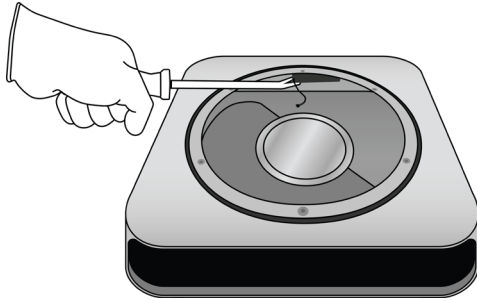

Tools Used

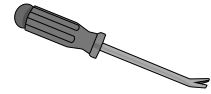

Fraction

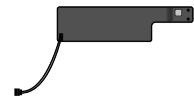

Bluetooth antenna

Cu

Copper

Fraction









Enclosure

Al

Aluminum

Material Categorization of Output Fractions

All outputs from this process must be managed, handled, and disposed of in accordance with applicable waste laws and regulations, including but not limited to the Waste Framework Directive and its national enactments in Europe.

Fraction	Downstream Processing
<p>Aluminum</p>  <p><i>Shield</i></p>  <p><i>Enclosure</i></p>	<p>Primary Target Material</p>  <p>Potential Additional Materials</p> 
<p>Batteries</p>  <p><i>Coin cell battery</i></p>	<p>Primary Target Material</p> 

Fraction

Downstream Processing

Ferrous

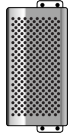

Heat shield



Mounting straps



Adapter ring



Fasteners (x31)

Primary Target Material



Fraction

Downstream Processing

Logic Boards

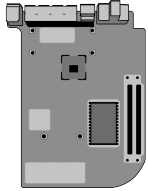

Main logic board

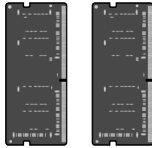

Memory modules



Power supply logic board

Primary Target Material



Potential Additional Materials



Fraction

Downstream Processing

Mixed Electronics



Power cord

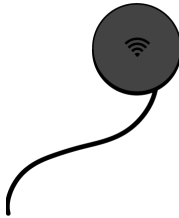

Wi-Fi antenna



Fan



Battery bracket

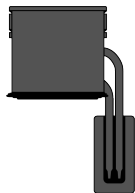

*Heat sink and
heat sink channels*

Primary Target Material



Potential Additional Materials



Mixed Electronics (cont.)

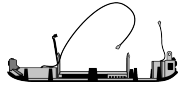

Front face



Wires and adapter

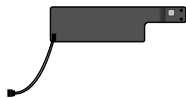

Bluetooth antenna

Mixed Plastics



Dust cover

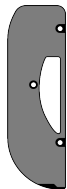

Power supply cover

Primary Target Material



Potential Additional Materials



Fraction

Downstream Processing

Rare Earth Magnets



Speaker

Primary Target Material



Potential Additional Materials

