



iPhone 13 Pro

iPhone 13 Pro Max

Apple Recycler Guide

June 2023

Contents

3	About This Guide
4	Identification
5	Directive 2012/19/EU Annex VII Components
6	Safety Considerations
9	Recommended Tools
10	Disassembly Instructions
26	Material Categorization of Output Fractions

About This Guide

Apple Recycler Guides provide guidance for electronics recyclers on how to disassemble products to maximize recovery of resources. The guides provide step-by-step disassembly instructions and information on the material composition to help recyclers direct fractions to the appropriate material recycler.

To conserve important resources, we work to reduce the materials we use and aim to one day source only recycled or renewable materials in our products. A key path to reaching that goal is resource recovery from end-of-life electronics.

Disassembly procedures are intended to be performed only by trained electronics recycling professionals. The recycler is responsible for independently evaluating and ensuring compliance with all applicable environmental, health, and safety laws related to the work. These include but are not limited to laws relating to the management, handling, shipping, and disposal of the outputs of this work as waste and laws in place to ensure the health and safety of all employees who support this work.

For questions or feedback about this guide, email contactesci@apple.com.

Note: This guide may show images from other similar models, but the procedures are the same.

Identification

You can find the model number of the iPhone inside the SIM tray slot.

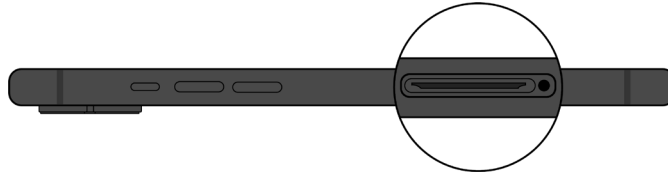

Model numbers:

*A2483, A2484, A2636, A2638, A2639,
A2640, A2641, A2643, A2644, A2645*

Directive 2012/19/EU Annex VII Components

Directive 2012/19/EU Annex VII requirements apply to the following substances and components.

Substance/Component	Apple Part Name	Removal Instructions
Printed circuit board if the surface is greater than 10 square centimeters	Main logic board	Follow steps 1–14
External electric cables	Charge cable	Follow step 1
Battery	Lithium-ion polymer battery	Follow steps 1–6
Cover glass and organic light-emitting diode (OLED) display if the surface is greater than 100 square centimeters	OLED display	Follow steps 1–5
No further substances or components as listed in Annex VII		

Safety Considerations

The recycler is responsible for independently evaluating all activities undertaken by its employees to perform or support the work and ensuring compliance with all applicable health and safety laws related to the work. These include but are not limited to laws relating to the health and safety of all employees who perform or support this work. The recycler is also responsible for evaluating the workspace and ensuring that the area in which the work is to be undertaken is designed using ergonomic best practices and meets all ergonomic requirements to ensure the protection of its employees.

Personal Protective Equipment

Personal protective equipment should be worn during the entire recycling process.



Wear hand protection



Wear foot protection



Wear eye protection



Wear a mask



Wear protective clothing

Battery Safety

This product uses a lithium-ion polymer battery. Before beginning any disassembly work, ensure that a safe working procedure for handling lithium-ion batteries has been established, which could include discharging the batteries so that they can be more safely managed. The following considerations may also be included:

- Remove anything from your person that could conduct energy, such as jewelry and watches, to avoid electric shock to yourself or the logic board.
- To avoid the potential for thermal runaway and the release of potentially noxious fumes, don't puncture, strike, or crush lithium-ion polymer batteries or devices powered by them.
- Don't throw, drop, or bend the battery.
- Don't expose the battery to excessive heat or sunlight.
- Don't use tools that are sharp or conduct electricity.
- Keep your workspace clear of foreign objects and sharp materials.
- Dispose of batteries according to local environmental laws and guidelines.

Workspace safety guidelines

- Use heat-resistant gloves and safety glasses.
- Keep a sand dispenser within arm's reach (2 feet or 0.6 m) on one side of the workstation, not above the workstation. The dispenser should be a wide-mouthed, quick-pour metal container with a flip-top lid or tray that contains 8–10 cups (1.9–2.4 L) of clean, dry, untreated sand.
- Keep the battery at least 2 feet (0.6 m) from paper and other combustible materials.
- Work in an area with adequate ventilation.

Handling a thermal runaway

If you notice any of the following signs, a thermal runaway is likely underway, and you should act immediately:

- The lithium-ion polymer battery or a device containing one begins to smoke or emit sparks or soot.
- The battery pouch suddenly and quickly puffs out.
- You hear hissing or popping sounds.

Don't use water or an ABC/CO₂ fire extinguisher on a thermal runaway battery or a device containing one. Water and ABC/CO₂ fire extinguishers will not stop the reaction.

Do smother the battery or device immediately with plenty of clean, dry sand, dumped all at once. Timing is critical; the faster you pour all the sand, the faster the thermal runaway will stop.

Do leave the room for 30 minutes if the thermal runaway causes any irritation.

Do wait 30 minutes before touching the battery. Wear heat-resistant gloves and safety glasses to remove the battery from the sand, or use a touchless thermometer to measure the battery temperature. Only touch the battery when the event has finished.

Do dispose of the damaged battery or device (including any debris removed from the sand) according to local environmental laws and guidelines.

OLED Safety

Broken OLEDs must be handled properly to ensure the safety of your employees and mitigate any hazards. Package broken OLEDs in an appropriate container to properly manage the hazards associated with the materials and store only with compatible materials. All waste must be properly classified, packaged, and labeled in accordance with all relevant laws and regulations.

Hazard Warnings



Broken glass hazard



Rechargeable battery hazard



Chemical inhalation hazard

Recommended Tools

Flat-blade screwdriver

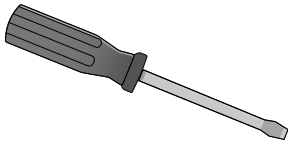

Miniature plastic pry bar

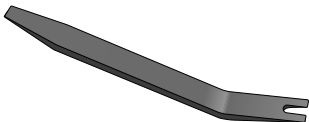

Miniature pry bar

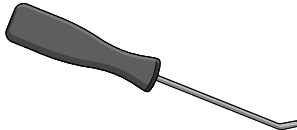

Slip-joint pliers

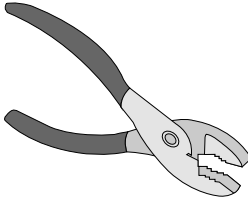

Tweezers



Disassembly Instructions

1. Remove the charge cable.

- » *Ensure that the iPhone is turned off.*
- » *Unplug the charge cable.*

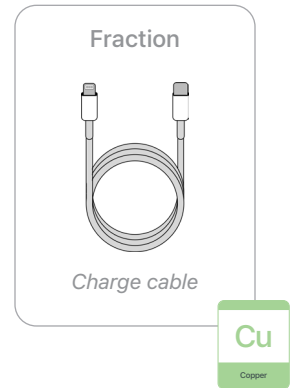

2. Remove the OLED display.



Broken glass hazard



Chemical inhalation hazard

- » *Hold the iPhone at the edge of a counter with the display faceup and the Lightning connector toward the counter edge.*
- » *Insert the tool tip into the Lightning connector. Push the handle down to pry the display from the enclosure.*

Tools Used

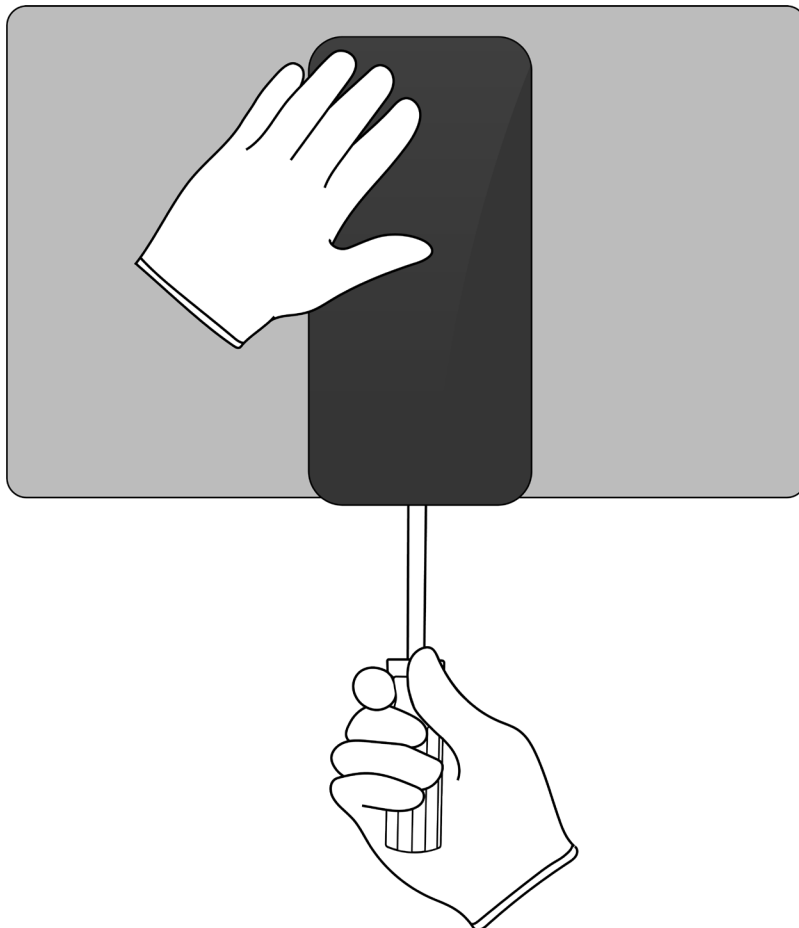
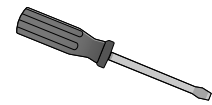

» Remove the display by hand. Set the enclosure aside.

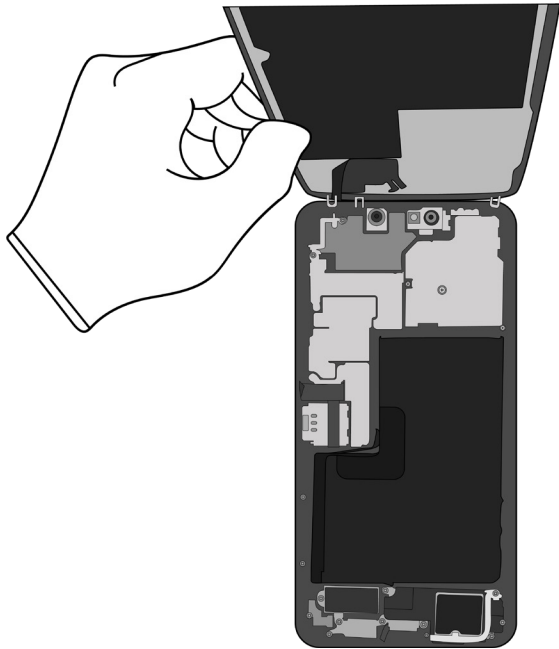

- 3.** With the display facedown, pry off the light sensor and microphone cover.

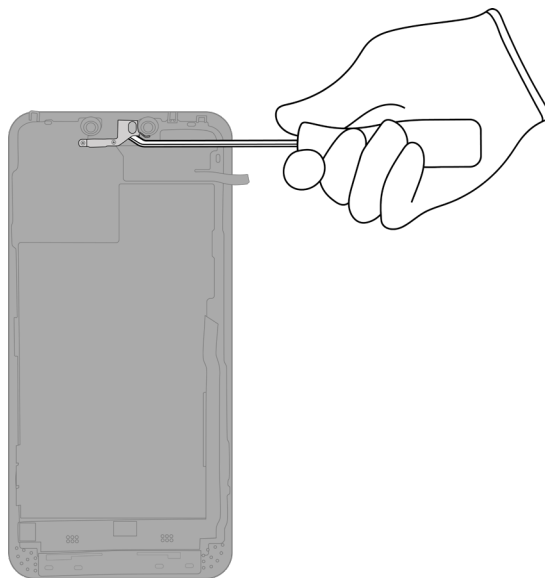

Tools Used



Fraction



Light sensor and microphone cover

Fe

Ferrous

4. Pry off the light sensor and microphone.

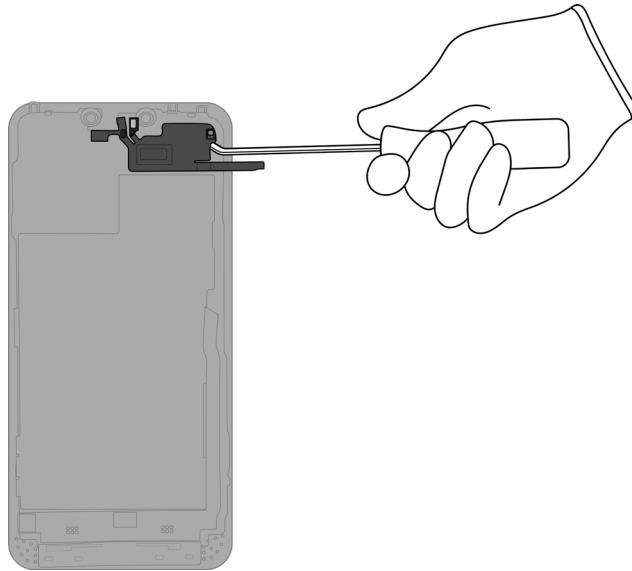

Tools Used



Fraction



*Light sensor and
microphone*

Cu
Copper

5. Remove the display logic board.

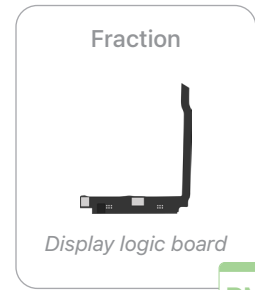
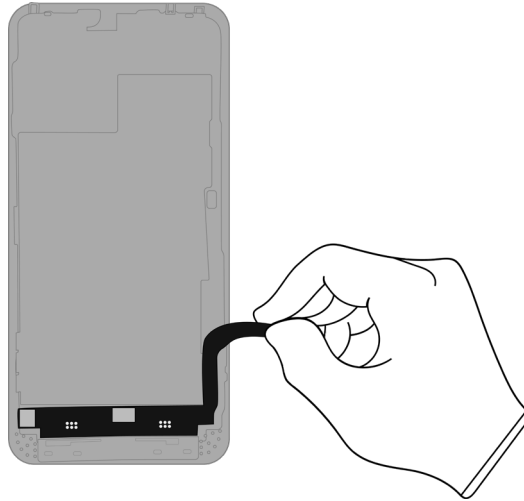

6. Inside the enclosure, carefully remove the lithium-ion polymer battery.



Rechargeable battery hazard

- » *Using tweezers, gently peel one of the battery adhesive tabs away from the battery.*
- » *Twist the tab around the tweezers until white adhesive appears. Continue twisting until the entire adhesive strip is removed.*
- » *Repeat this process for any remaining battery tabs. Continue with the miniature plastic pry bar if needed.*

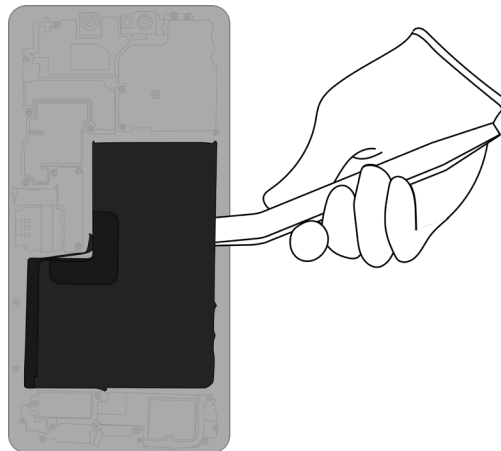

Tools Used



Fraction



Lithium-ion polymer battery

BT

Battery

7. Pry off the rear camera cover.

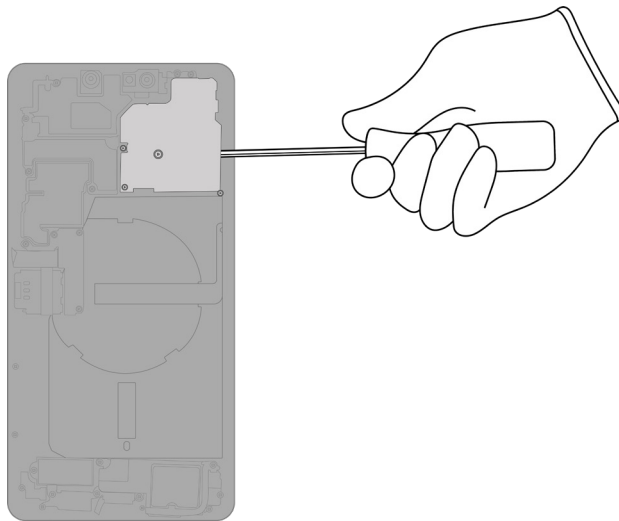

Tools Used



Fraction

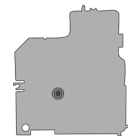

Rear camera cover

Fe

Ferrous

8. Pry off the rear camera.

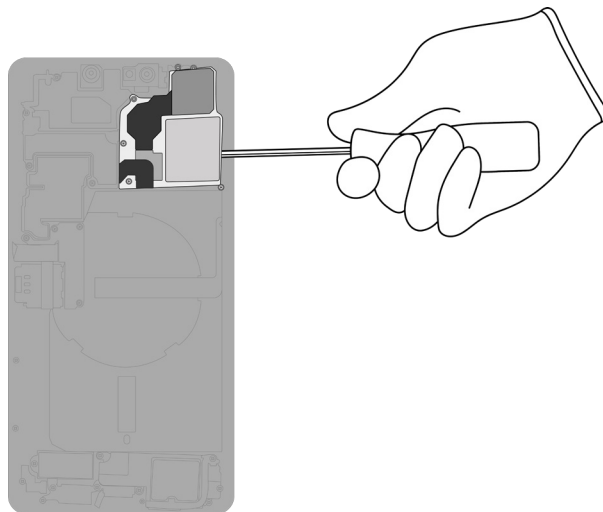

Tools Used



Fraction

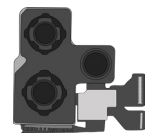

Rear camera

PMs

Precious Metals

9. Pry off the LiDAR Scanner cover.

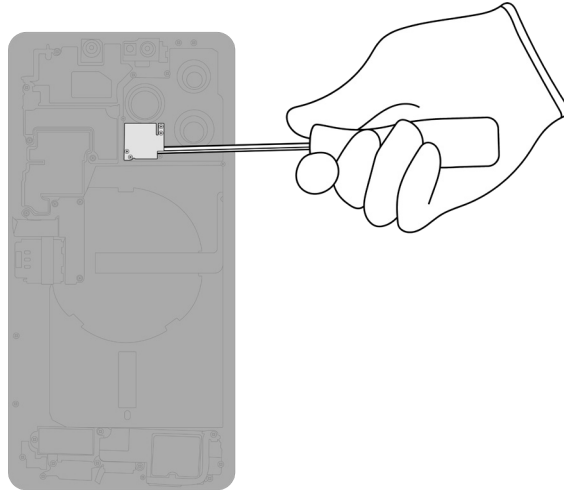

Tools Used



Fraction



LiDAR Scanner cover

Fe

Ferrous

10. Pry off the LiDAR Scanner.



Chemical inhalation hazard

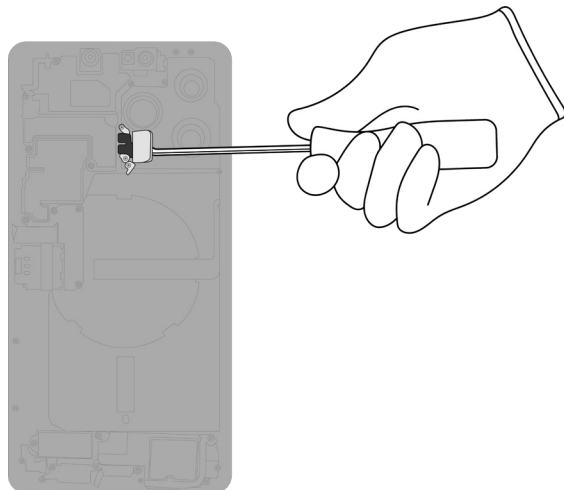

Tools Used



Fraction



LiDAR Scanner

PMs

Precious Metals

11. Pry off the receiver.

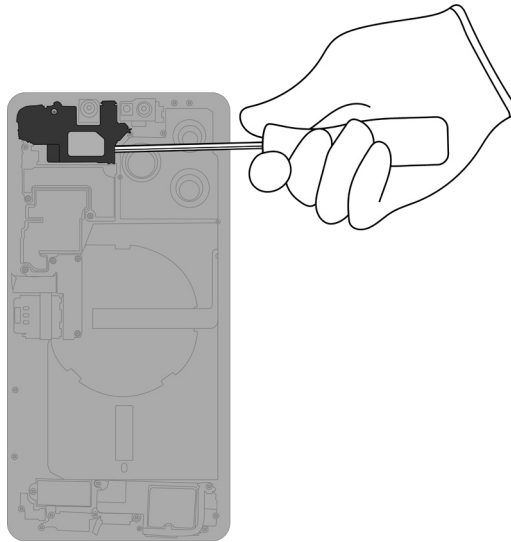

Tools Used



Fraction

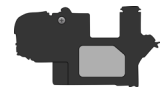

Receiver



12. Pry off the front camera.



Tools Used



Fraction

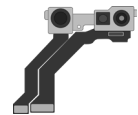

Front camera



- 13.** Remove the SIM card and SIM tray. Separate the SIM card from the SIM tray.

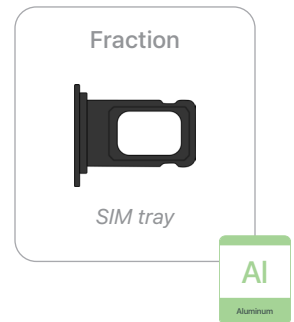
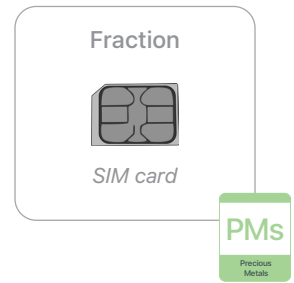
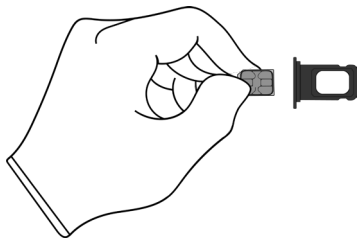
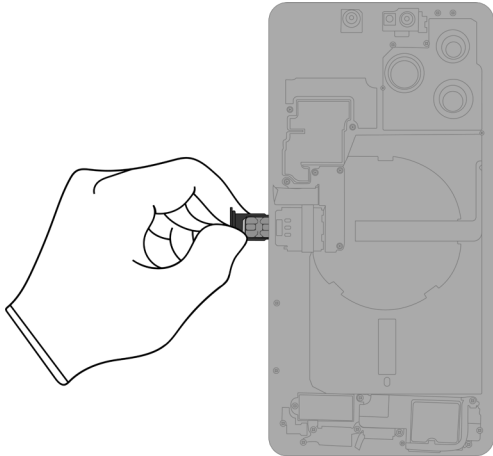

14. Pry off the main logic board.

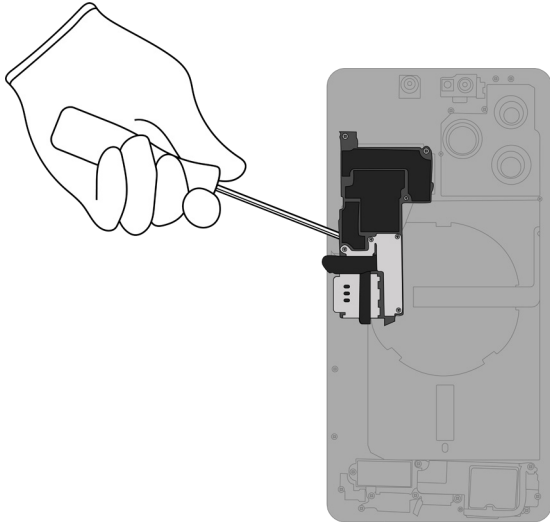

Tools Used



Fraction

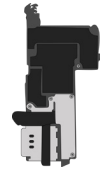

Main logic board

PMs

Precious Metals

15. Pry off the Taptic Engine.

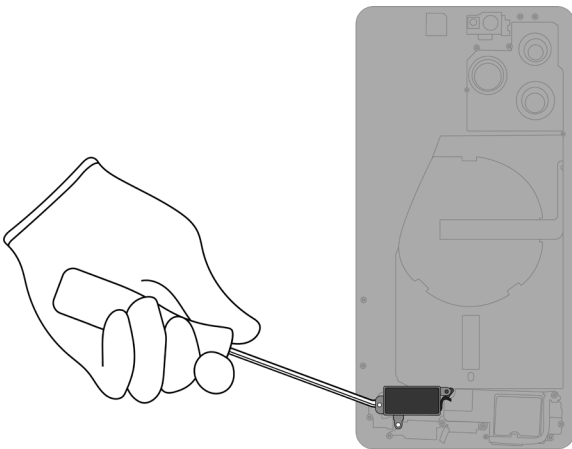

Tools Used



Fraction



Taptic Engine

REE

Rare Earth Elements

16. Pry off the speaker.

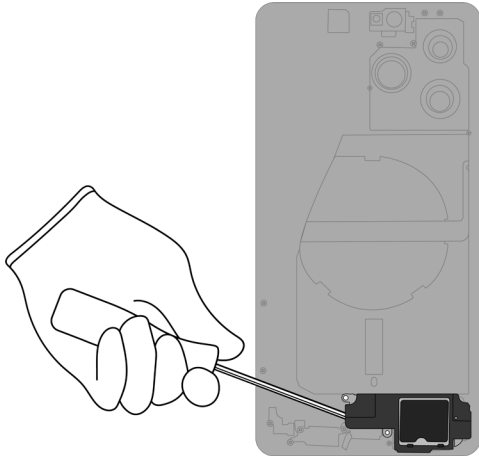

Tools Used



Fraction



Speaker

REE

Rare Earth
Elements

17. Pry off the Lightning connector.

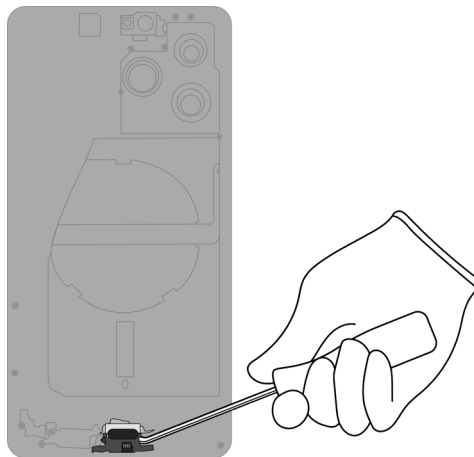

Tools Used



Fraction



Lightning connector

Cu

Copper

18. Pry off the microphone cover.

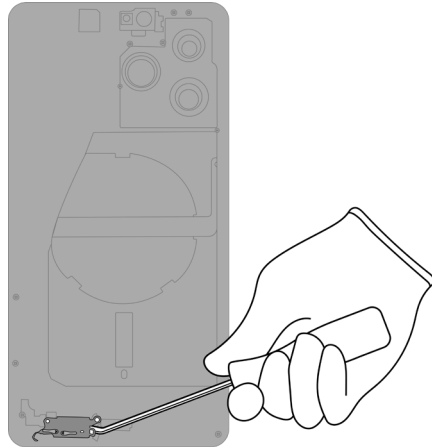

Tools Used



Fraction

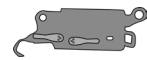

Microphone cover

Fe

Ferrous

19. Pry off the microphone and Lightning connector assembly.

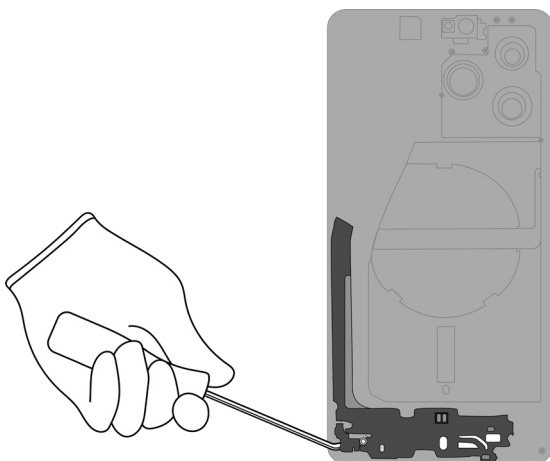

Tools Used



Fraction

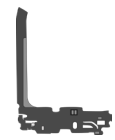

*Microphone and
Lightning connector
assembly*

Cu

Copper

20. Pry off the ribbon cables.

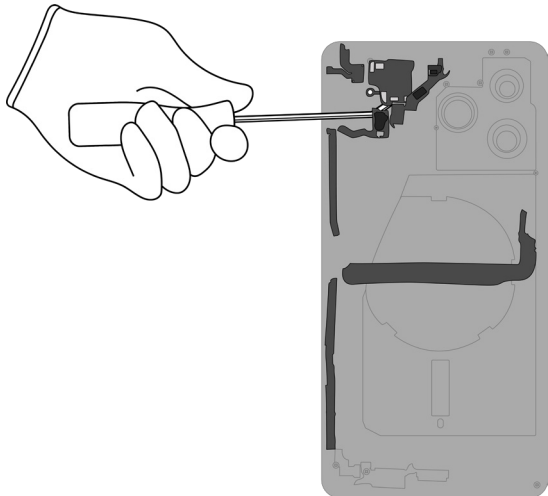

Tools Used



Fraction



Ribbon cables

Cu

Copper

21. Pry off the 5G antenna.

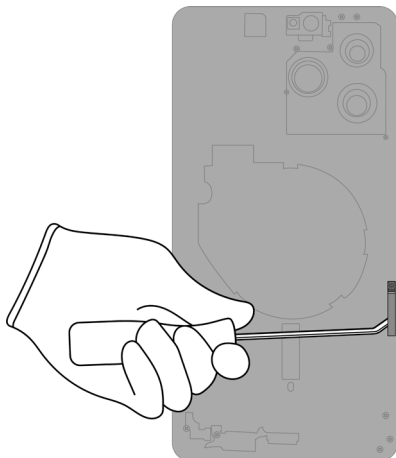

Tools Used



Fraction



5G antenna

Cu

Copper

22. Pull the enclosure band off the support plate.

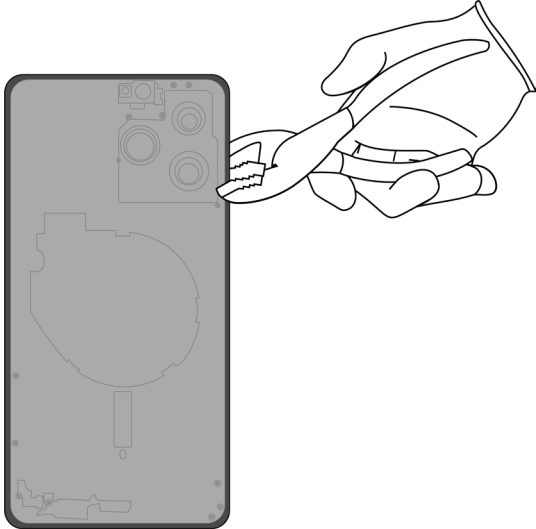

Tools Used

An illustration of a pair of pliers, showing the handles and the jaws.

Fraction

An illustration of the enclosure band, which is a dark gray rectangular frame with rounded corners.

Enclosure band

Fe

Ferrous

Fraction

An illustration of the support plate, which is a light gray rectangular plate with rounded corners and a central cutout.







Support plate

Cu

Copper

Material Categorization of Output Fractions

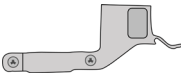
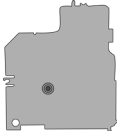
All outputs from this process must be managed, handled, and disposed of in accordance with applicable waste laws and regulations, including but not limited to the Waste Framework Directive and its national enactments in Europe.

Fraction	Downstream Processing
<p>Aluminum</p>  <p><i>SIM tray</i></p>	<p>Primary Target Material</p> 
<p>Batteries</p>  <p><i>Lithium-ion polymer battery</i></p>	<p>Primary Target Material</p> 
<p>Ferrous</p>  <p><i>Light sensor and microphone cover</i></p>  <p><i>Rear camera cover</i></p>	<p>Primary Target Material</p> 

Fraction

Downstream Processing

Ferrous (cont.)



LiDAR Scanner cover

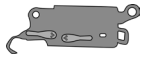

Microphone cover



Enclosure band

Glass



OLED display

Primary Target Material



Potential Additional Materials



Fraction

Downstream Processing

Logic Boards



Display logic board

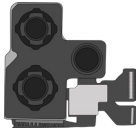

Rear camera



LiDAR Scanner

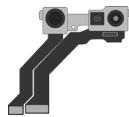

Front camera



SIM card

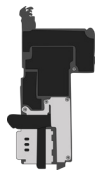

Main logic board

Primary Target Material



Potential Additional Materials



Fraction

Downstream Processing

Mixed Electronics

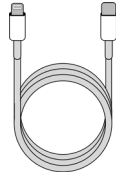

Charge cable



Light sensor and microphone



Lightning connector



Microphone and Lightning connector assembly



Ribbon cables



5G antenna

Primary Target Material



Potential Additional Materials



Mixed Electronics (cont.)

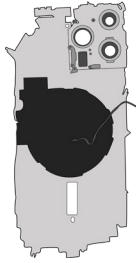

Support plate

Rare Earth Magnets

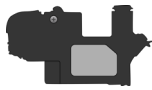

Receiver



Taptic Engine



Speaker

Primary Target Material



Potential Additional Materials

