



# Mac Pro (Rack, 2019)

## Apple Recycler Guide

May 2023

# Contents

- 3 [About This Guide](#)
- 4 [Identification](#)
- 5 [Directive 2012/19/EU Annex VII Components](#)
- 6 [Safety Considerations](#)
- 7 [Recommended Tools](#)
- 8 [Disassembly Instructions](#)
- 49 [Material Categorization of Output Fractions](#)

# About This Guide

Apple Recycler Guides provide guidance for electronics recyclers on how to disassemble products to maximize recovery of resources. The guides provide step-by-step disassembly instructions and information on the material composition to help recyclers direct fractions to the appropriate material recycler.

To conserve important resources, we work to reduce the materials we use and aim to one day source only recycled or renewable materials in our products. A key path to reaching that goal is resource recovery from end-of-life electronics.

Disassembly procedures are intended to be performed only by trained electronics recycling professionals. The recycler is responsible for independently evaluating and ensuring compliance with all applicable environmental, health, and safety laws related to the work. These include but are not limited to laws relating to the management, handling, shipping, and disposal of the outputs of this work as waste and laws in place to ensure the health and safety of all employees who support this work.

For questions or feedback about this guide, email [contactesci@apple.com](mailto:contactesci@apple.com).

# Identification

You can find the model number on the back of the Mac Pro (Rack, 2019).



*Model number:*  
A2304

# Directive 2012/19/EU Annex VII Components

Directive 2012/19/EU Annex VII requirements apply to the following substances and components.

Substance/Component	Apple Part Name	Removal Instructions
Printed circuit board if the surface is greater than 10 square centimeters	Main logic board, graphics processing unit (GPU) logic board, power supply logic board, input/output (I/O) card, memory modules, and processor	Follow steps 1–44
External electric cables	Power cord	Follow step 1
Battery	Coin cell battery	Follow steps 1–20
No further substances or components as listed in Annex VII		

# Safety Considerations

The recycler is responsible for independently evaluating all activities undertaken by its employees to perform or support the work and ensuring compliance with all applicable health and safety laws related to the work. These include but are not limited to laws relating to the health and safety of all employees who perform or support this work. The recycler is also responsible for evaluating the workspace and ensuring that the area in which the work is to be undertaken is designed using ergonomic best practices and meets all ergonomic requirements to ensure the protection of its employees.

## Personal Protective Equipment

Personal protective equipment should be worn during the entire recycling process.



Wear eye protection



Wear protective clothing



Wear hand protection



Wear foot protection

## Hazard Warning



Sharp edges—cut hazard

# Recommended Tools

4.5 mm L-key

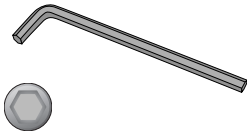

Miniature pry bar

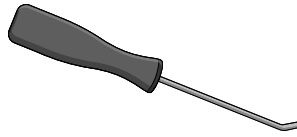

Nail-pulling screwdriver

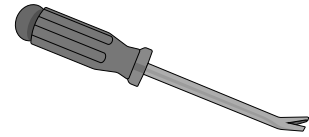

Phillips screwdriver

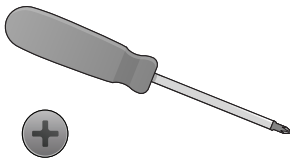

Screwdriver-handle pry bar

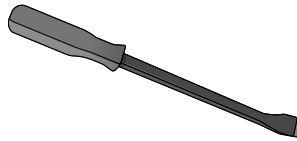

Torx T3 screwdriver

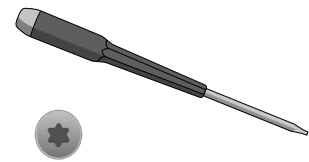

Torx T5 screwdriver

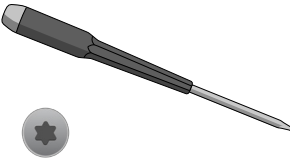

Torx T8 screwdriver

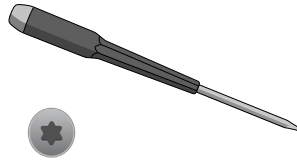

Torx T10 screwdriver

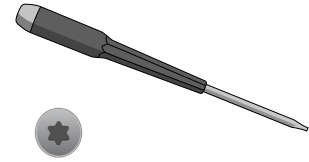

Torx T15 screwdriver

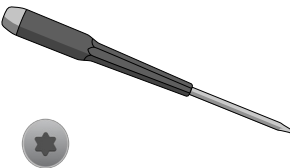

Wire cutters

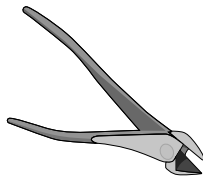

# Disassembly Instructions

## 1. Remove the power cord.

» *Ensure that the Mac Pro is turned off.*



» *Unplug the power cord from the back of the computer.*

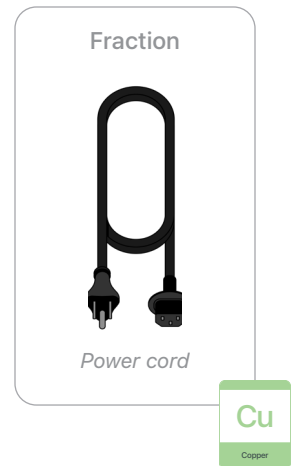

**Warning:** Before continuing disassembly, wait 10 minutes after unplugging the device for stored energy to discharge.



## 2. Remove the top panel.

- » *With the handles facing forward, release the latch on each side of the housing.*

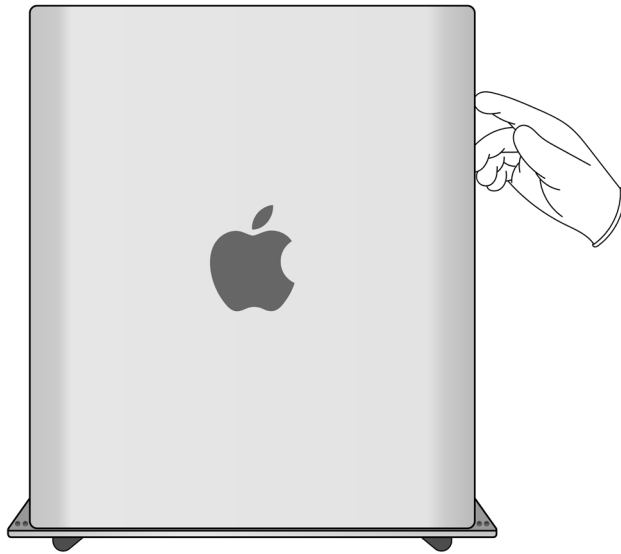

- » *Pull off the top panel.*

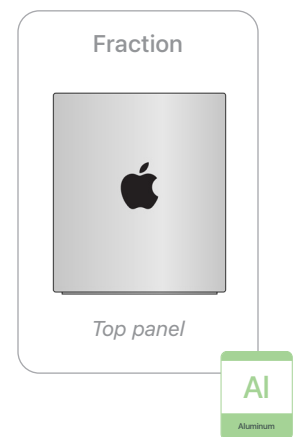
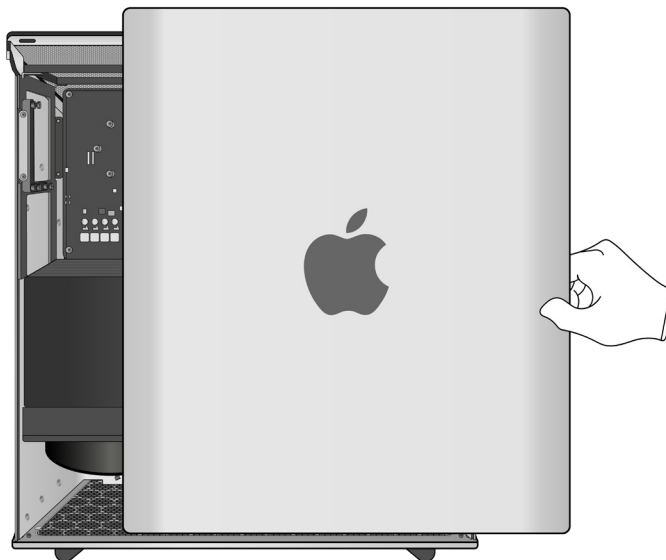

- 3.** Unscrew the 11 Torx T10 fasteners on each side of the housing.

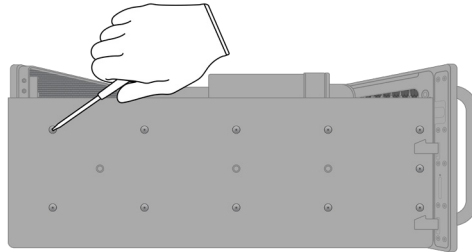

Tools Used

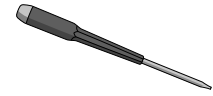

Fraction



Fasteners (x22)

Fe

Ferrous

- 4.** Pull off the front plate. Set the housing aside.

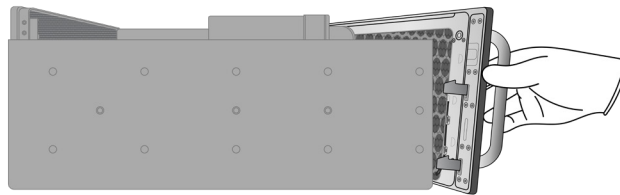

5. Remove the power button logic board by unscrewing the four Torx T5 fasteners.

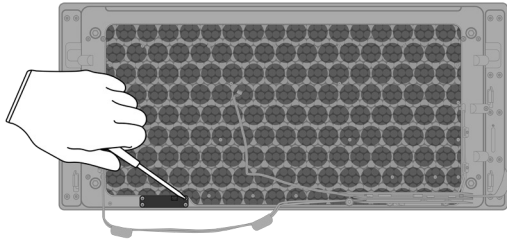

Tools Used

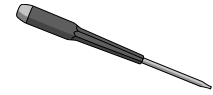

Fraction



Fasteners (x4)

Fe

Ferrous

Fraction



Power button  
logic board

PMs

Precious  
Metals

## 6. Remove the top I/O card.

» Unscrew the three Torx T10 fasteners.

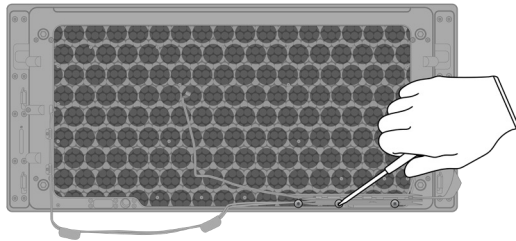

» Cut off the surrounding wires to remove the top I/O card. Set the front plate aside.

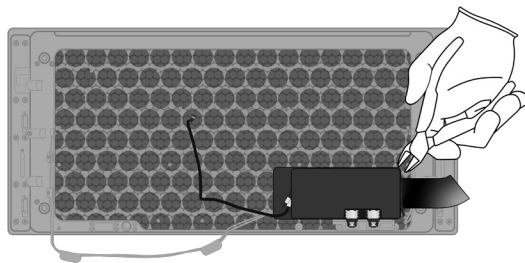

### Tools Used

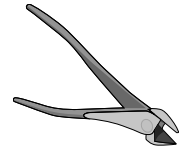
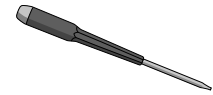

### Fraction



Fasteners (x3)

Fe

Ferrous

7. Pull the plastic sheets off the top I/O card.

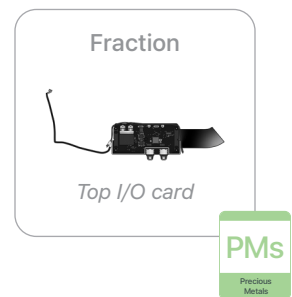
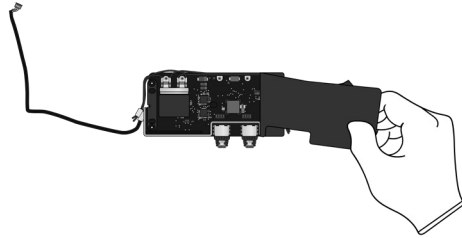

8. On the front plate, remove the handles by unscrewing the four 4.5 mm fasteners.

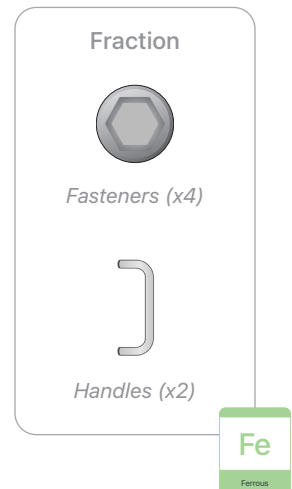
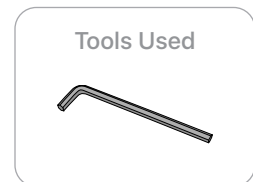
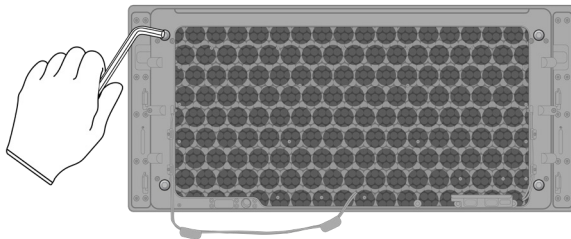

## 9. Remove the antennas.

» Unscrew the eight Torx T5 fasteners.

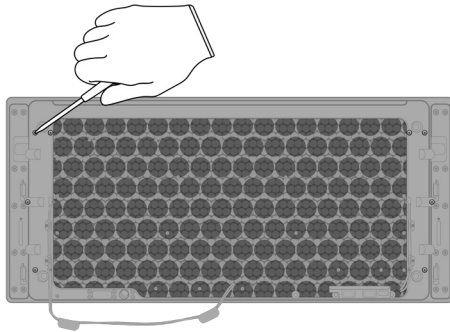

### Tools Used

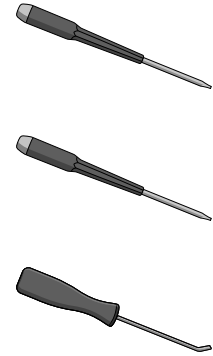

» Unscrew the eight Torx T3 fasteners.

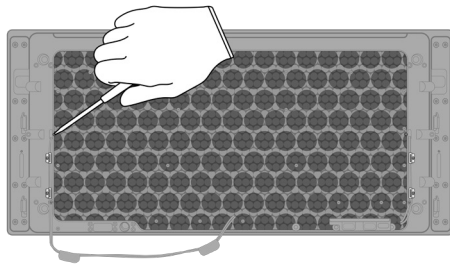

### Fraction



Fasteners (x16)

Fe

Ferrous

» Flip over the front plate and remove the antenna covers by hand. Set the front plate aside.

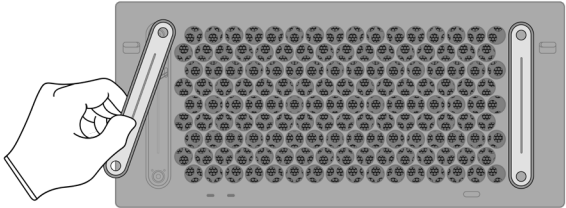

» Using the miniature pry bar, pry off the antennas.

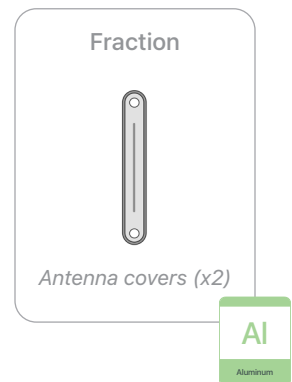
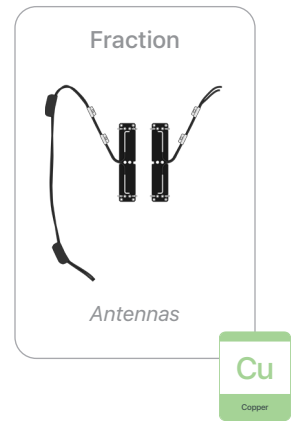
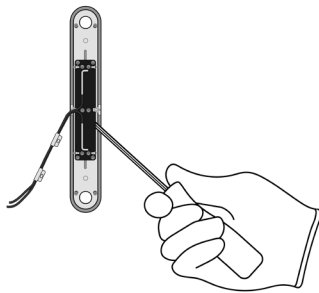

- 10.** On the back of the front plate, unscrew the 10 Torx T8 fasteners from both latch assemblies.

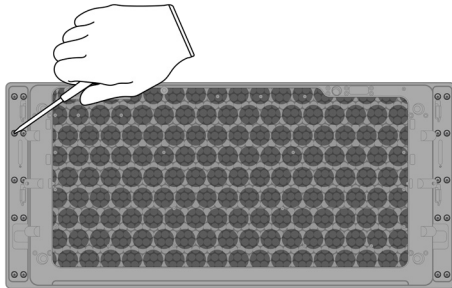

Tools Used

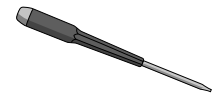

Fraction



Fasteners (x20)



Latch assemblies (x2)

Fe

Ferrous

Fraction



Front plate

Al

Aluminum



**11.** Slide the internal assembly out of the housing.

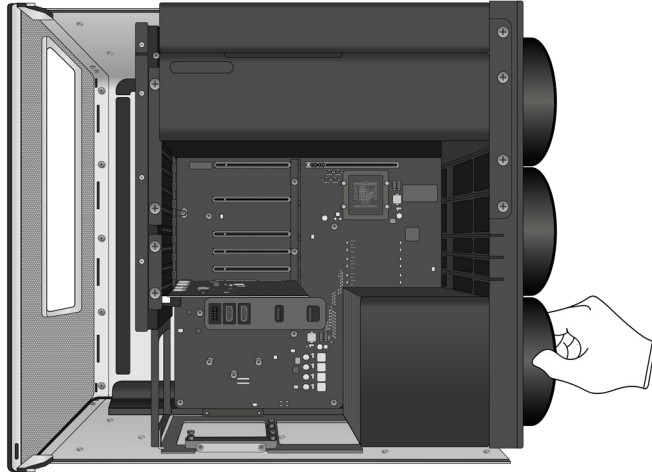

**12.** Pull the two foam cushions off the housing.

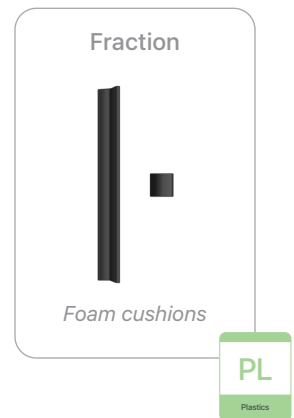
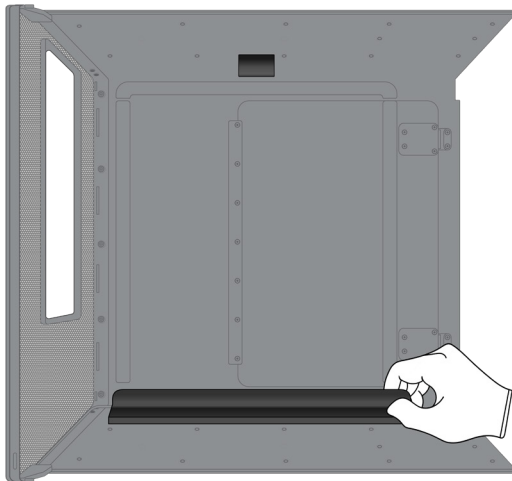

### 13. Pry off the Hall effect sensor.

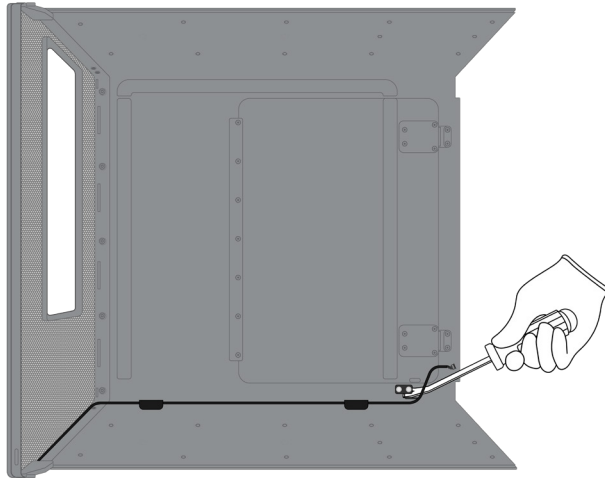

#### Tools Used

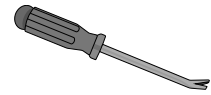

#### Fraction



Hall effect sensor

Cu

Copper

#### Fraction

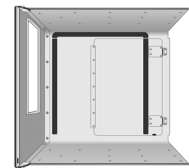

Housing

Al

Aluminum

## 14. Remove the retaining brackets.

- » On the internal assembly, loosen the four Phillips fasteners from the two retaining brackets on the right side. Then loosen the four Phillips fasteners from the left retaining bracket. Set the internal assembly aside.

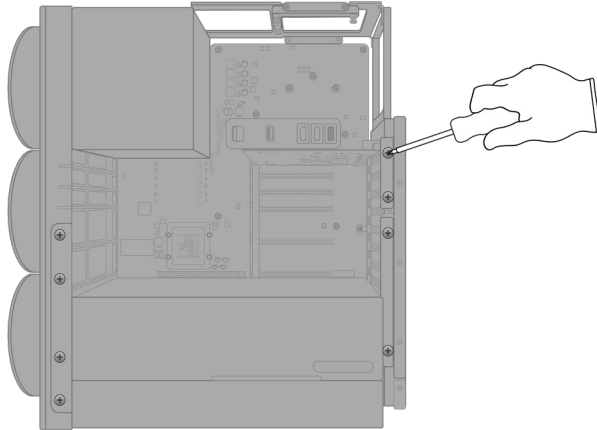

### Tools Used

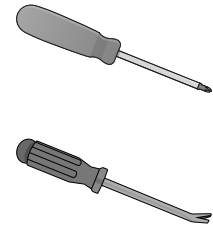

- » Pry off the fasteners and springs.

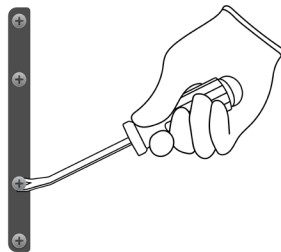

### Fraction



Fasteners (x8)

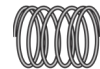

Springs (x8)

Fe

Ferrous

### Fraction

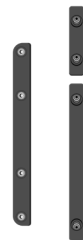

Retaining brackets

Al

Aluminum

- 15.** Remove the I/O card by sliding the PCI Express lock to the unlocked position.

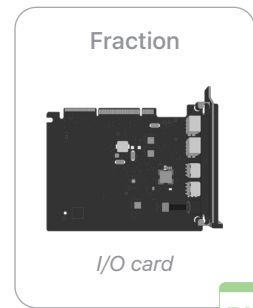
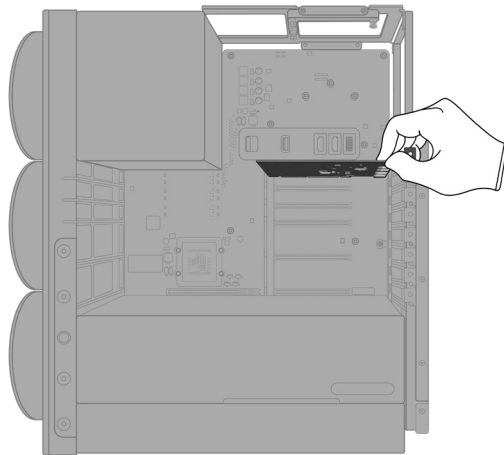
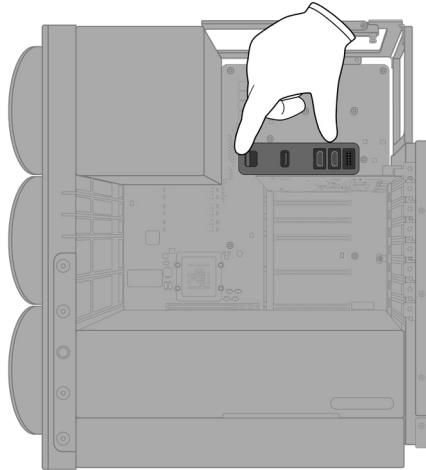

- 16.** Using the ejector latch, slide the GPU off the main logic board.

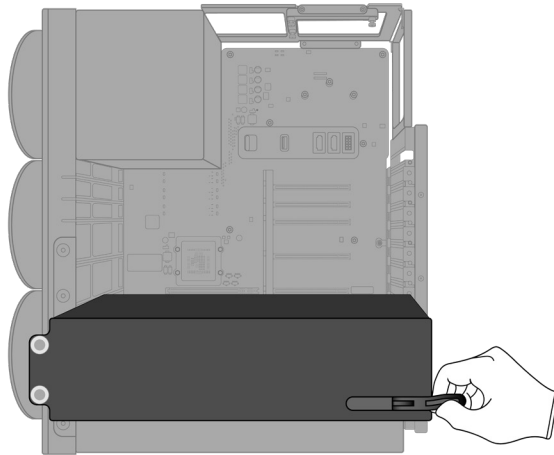

## 17. Disassemble the GPU.

» *Peel off the Mylar film by hand.*



» *Unscrew the one Torx T8 fastener.*

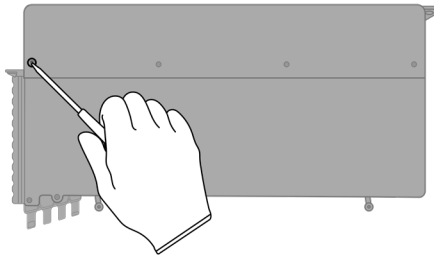

» *Unscrew the five Torx T5 fasteners.*

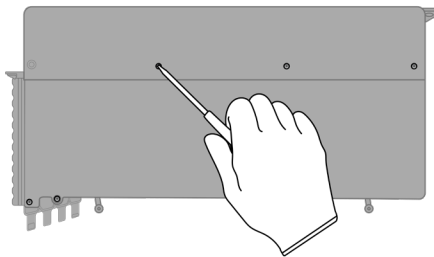

### Tools Used

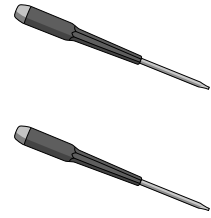

### Fraction



Mylar film

PL

Plastics

### Fraction



Fasteners (x6)

Fe

Ferrous

## 18. Remove the center bracket.

» Flip the GPU over. Unscrew the 10 Torx T8 fasteners.

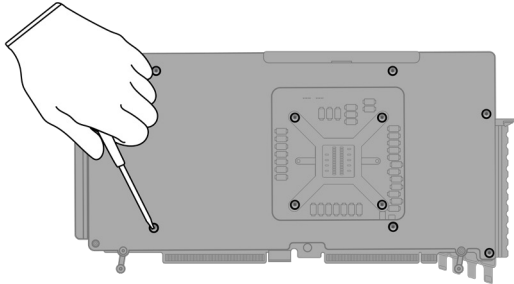

### Tools Used



» Unscrew the three Torx T5 fasteners. Pull off the center bracket.

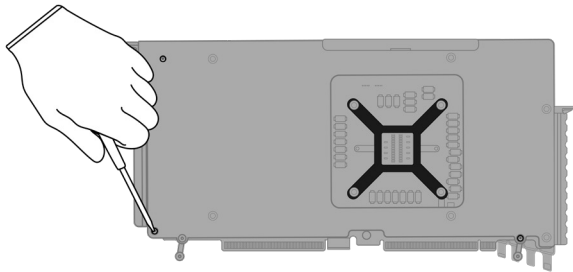

### Fraction



Fasteners (x13)

Fe

Ferrous

### Fraction

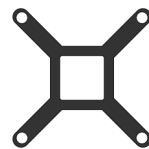

Center bracket

Al

Aluminum

## 19. Remove the heat sink and GPU logic board.

» Pull off the front face of the GPU.

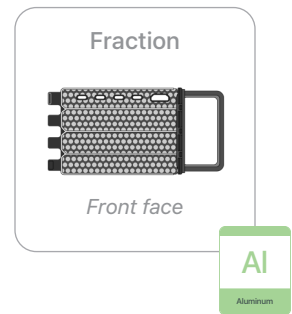
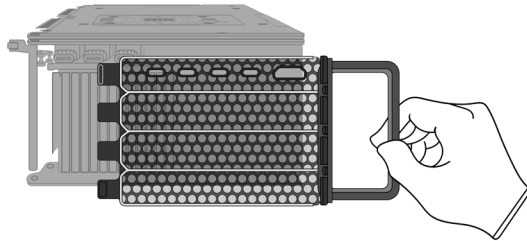

» Separate the GPU housing from the heat sink.

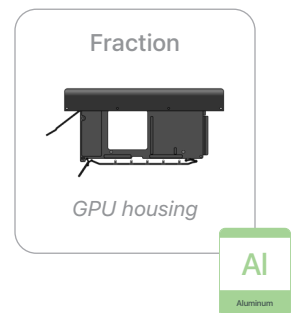
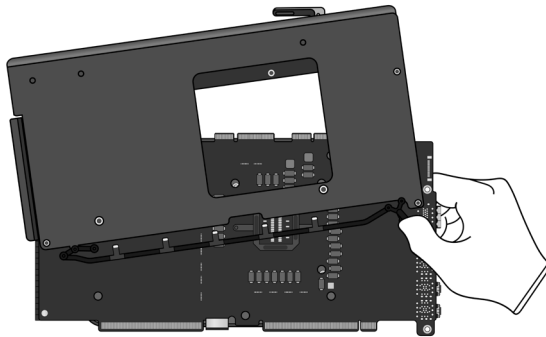

» Pull the GPU logic board off the heat sink.

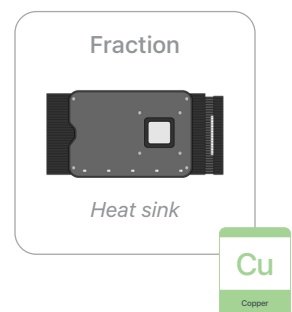
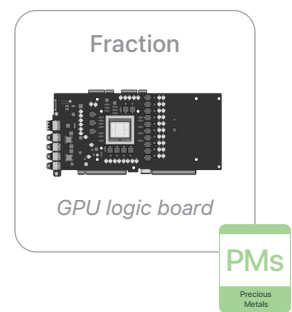
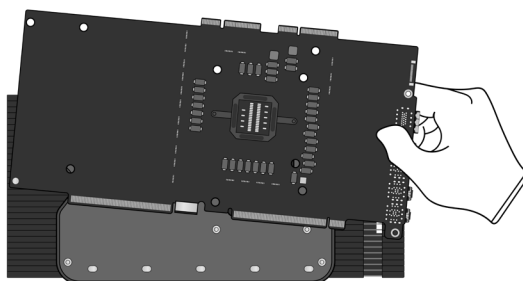



- 20.** Remove the coin cell battery from the main logic board.

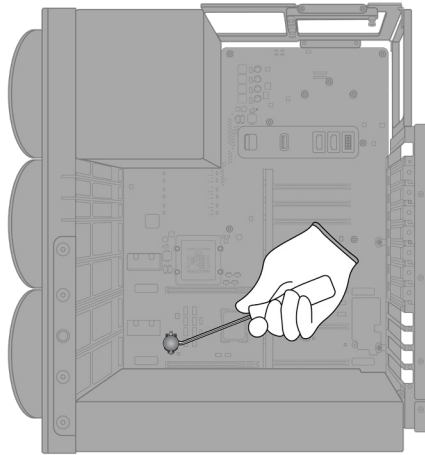

Tools Used



Fraction



Coin cell battery

BT

Battery

- 21.** Slide out the power supply enclosure by unscrewing the one Torx T8 fastener.

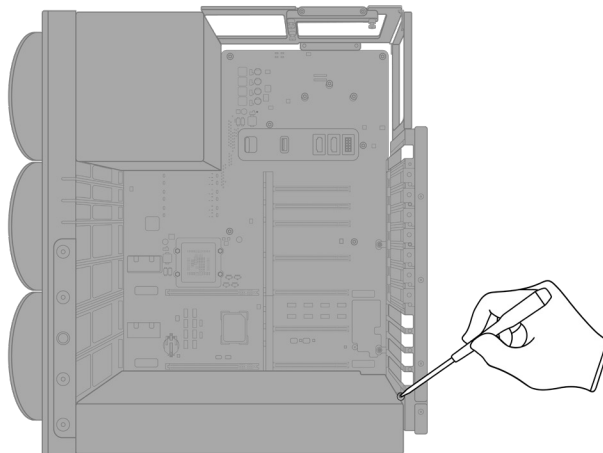

Tools Used

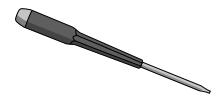

Fraction



Fastener

Fe

Ferrous

**22.** Unscrew the 10 Torx T8 fasteners from the power supply enclosure.

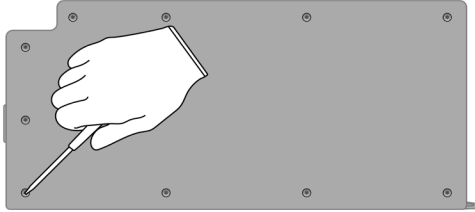

Tools Used

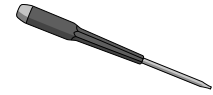

Fraction



Fasteners (x10)

Fe

Ferrous

## 23. Remove the power supply logic board.



Sharp edges—cut hazard

- » Pry open the power supply enclosure by hand.

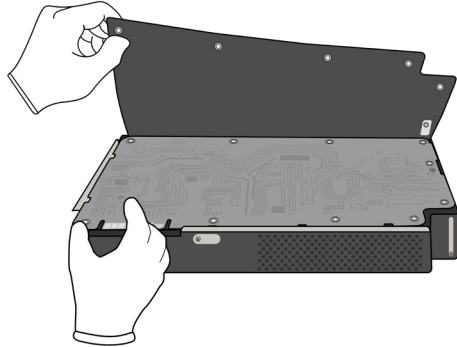

- » Unscrew the one Torx T8 fastener from the power supply logic board.

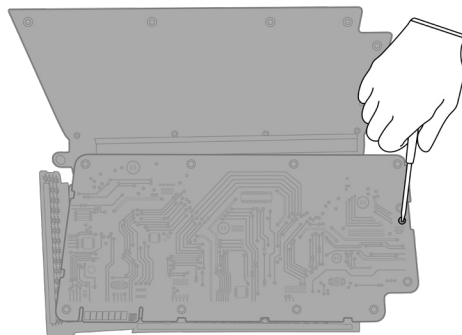

- » Separate the power supply logic board from its enclosure by cutting the wires.

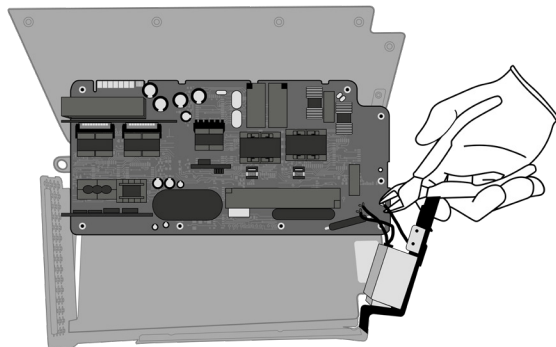

### Tools Used

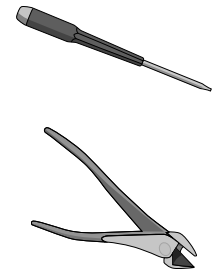

### Fraction



Fastener

Fe

Ferrous

### Fraction

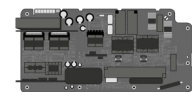

Power supply  
logic board

PMs

Precious  
Metals

**24.** Remove the power adapter by unscrewing the one Torx T8 fastener and washer.

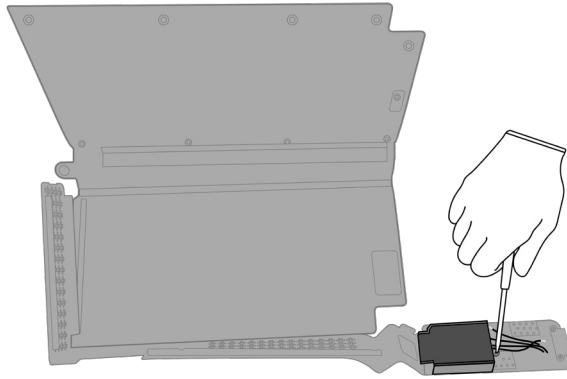

Tools Used

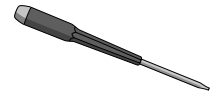

Fraction



Fastener



Washer

Fe

Ferrous

Fraction



Power adapter

Cu

Copper

Fraction

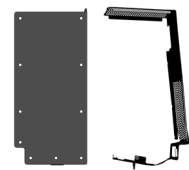

Power supply logic  
board housing

Al

Aluminum

- 25.** On the internal housing, slide the memory module cover latch to the unlock position. Remove both memory module covers.

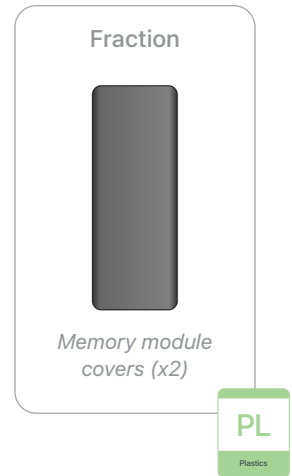
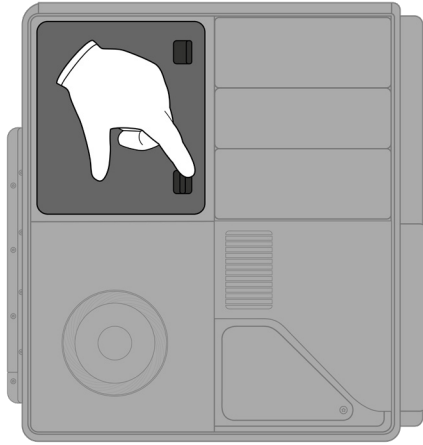

## 26. Remove the memory modules.

- » *Unlatch the memory modules by pushing the memory module ejectors.*

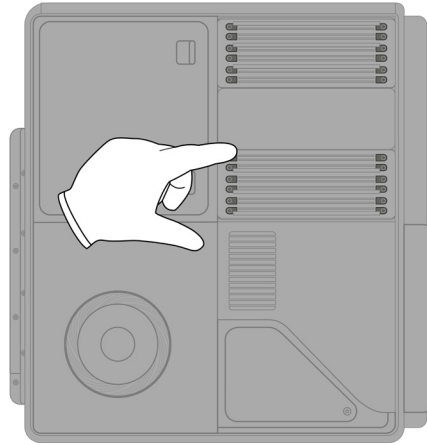

- » *Pull out the six memory modules.*

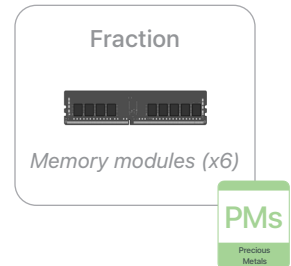
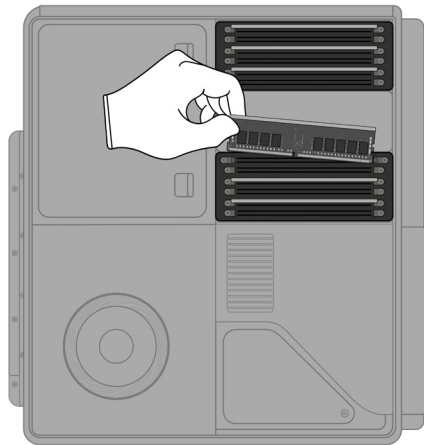

**27.** Remove the speaker by sliding it to the left and tilting it forward.

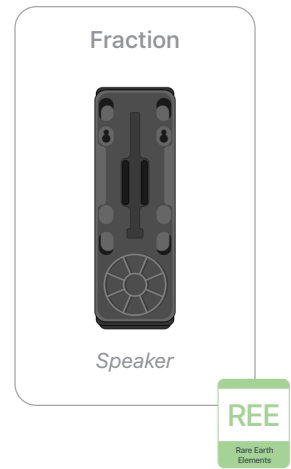
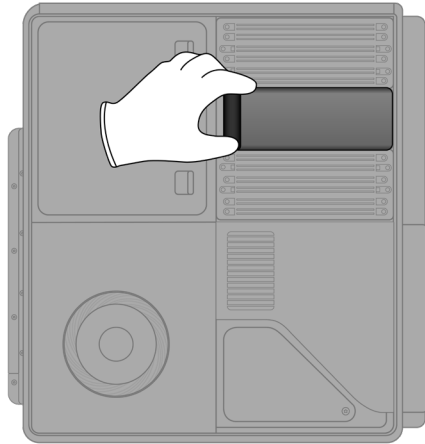

**28.** Remove the thermal module.

» *Unscrew the four Torx T15 fasteners and springs.*

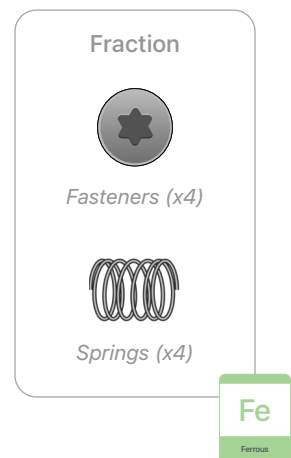
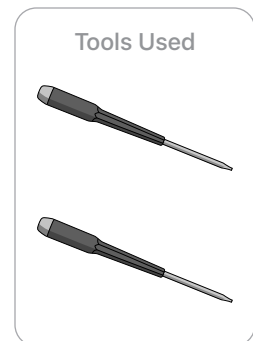
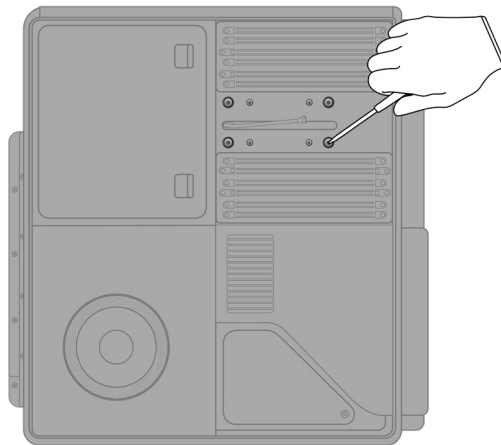

» *Flip the assembly around. Unscrew the two Torx T8 fasteners from the thermal module.*

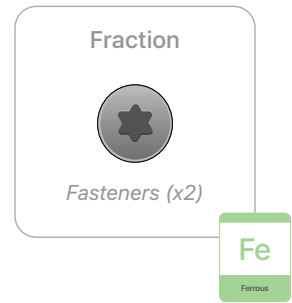
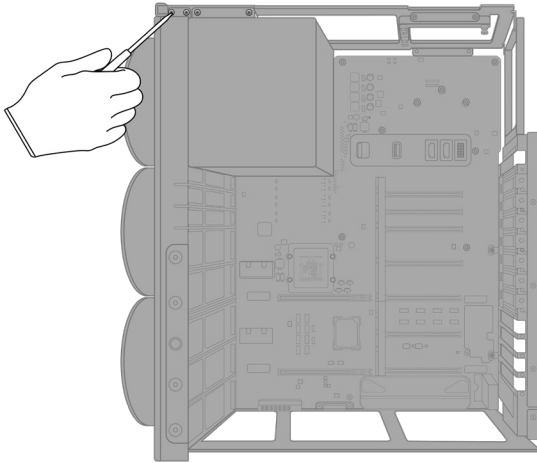

» *Slide out the thermal module.*

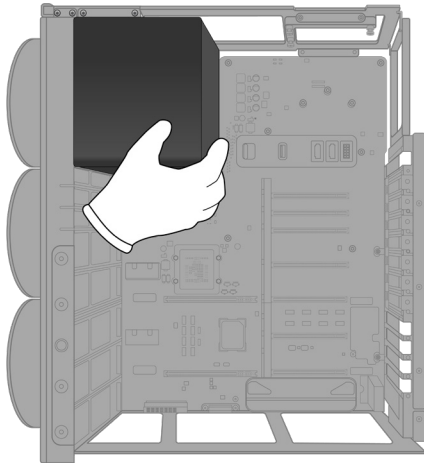



**29.** Lay the thermal module facedown. Lift out the processor.

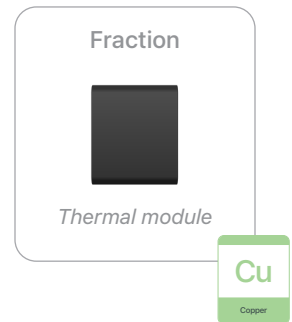
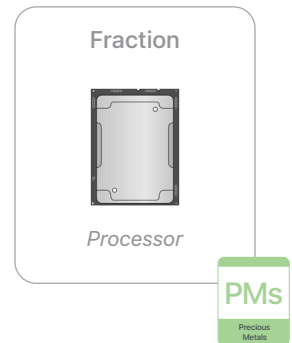
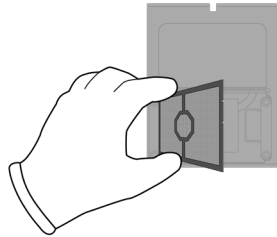

**30.** Remove the duct and blower.

» *Unscrew the three Torx T8 fasteners from the main logic board.*

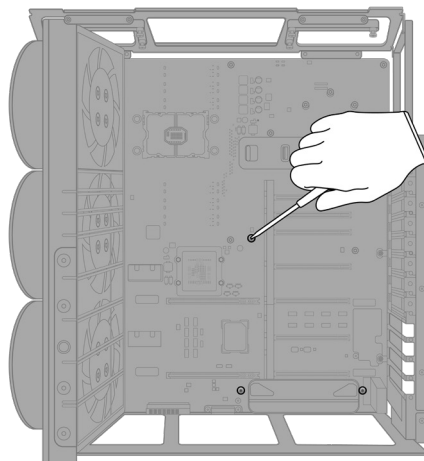

» Flip the assembly around and pull off the duct and blower.

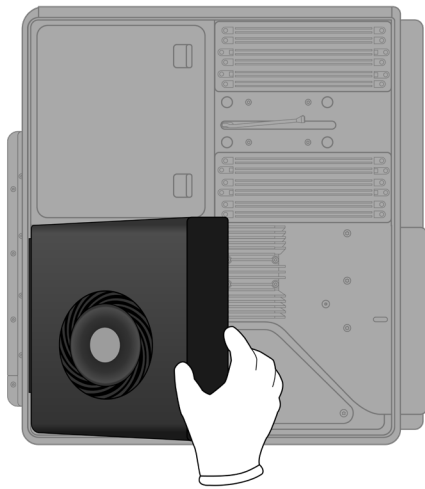
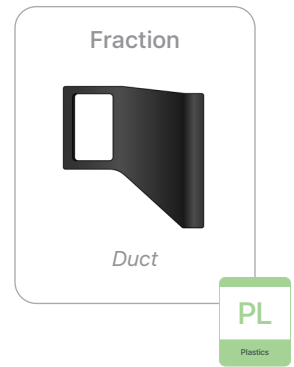
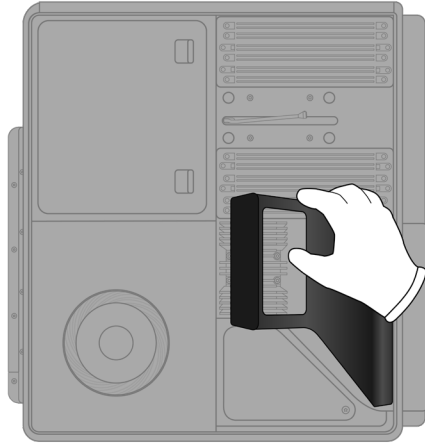

- 31.** Remove the heat sink by unscrewing the four Torx T8 fasteners and springs.

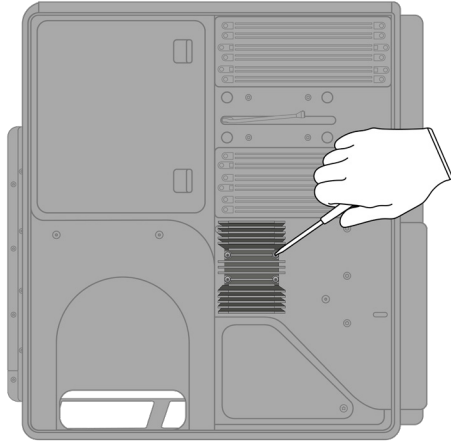

Tools Used

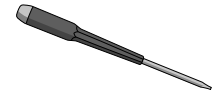

Fraction



Fasteners (x4)

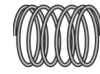

Springs (x4)

Fe

Ferrous

Fraction

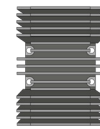

Heat sink

Cu

Copper

## 32. Remove the fan assembly.

- » *Unscrew the three Torx T8 fasteners from the fan assembly.*

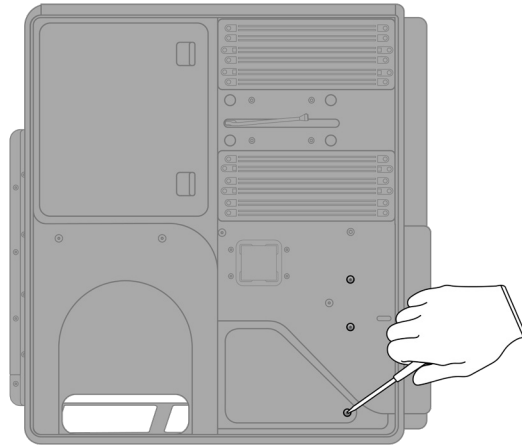

### Tools Used

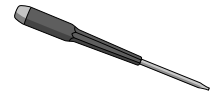

- » *Turn the internal assembly around. Unscrew the two Torx T8 fasteners from the top of the fans. Then unscrew the one Torx T8 fastener at the bottom.*

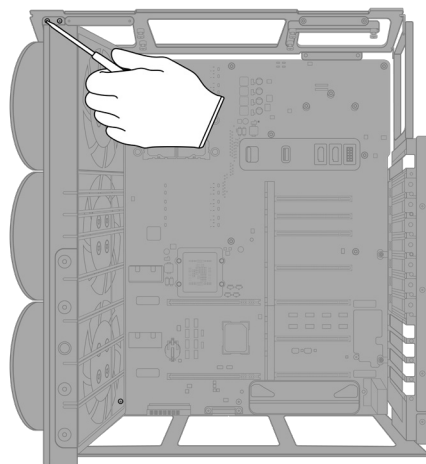

### Fraction



Fasteners (x6)

Fe

Ferrous

- » *Separate the fan assembly from the internal assembly.  
Set the internal assembly aside.*

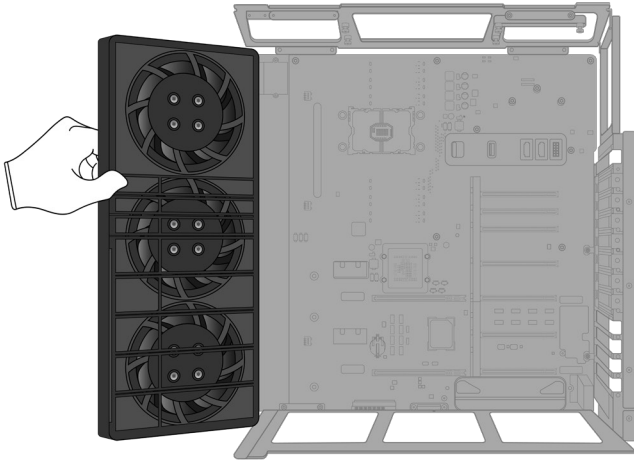

- 33.** *Unscrew the 12 Torx T8 fasteners from the fan assembly.*

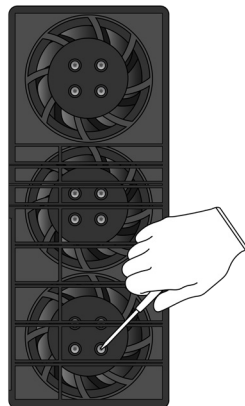

Tools Used

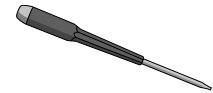

Fraction



Fasteners (x12)

Fe

Ferrous

## 34. Remove each fan.

» *Flip the fan assembly over and lift out the fans.*

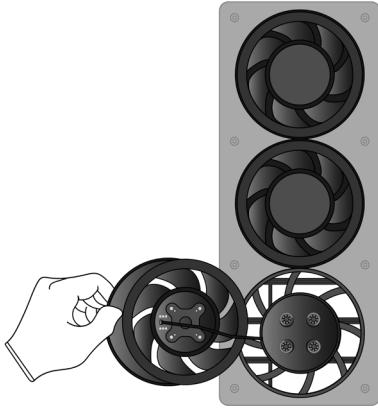

» *Disconnect the ribbon cable from each fan. Set the fans aside.*

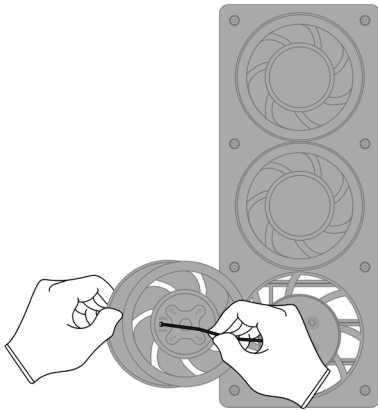

- 35.** Unscrew the eight Torx T8 fasteners from the fan assembly. Lift up the top piece.

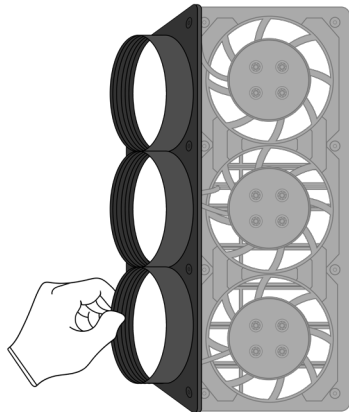
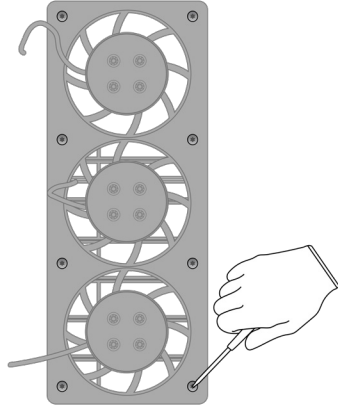

Tools Used

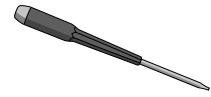

Fraction



Fasteners (x8)

Fe

Ferrous

- 36.** Remove the three ribbon cables from the fan assembly housing.

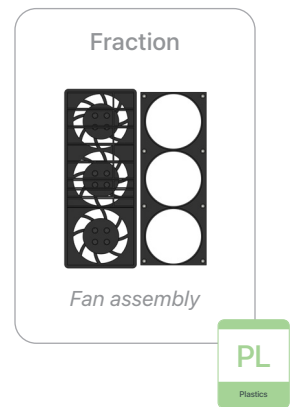
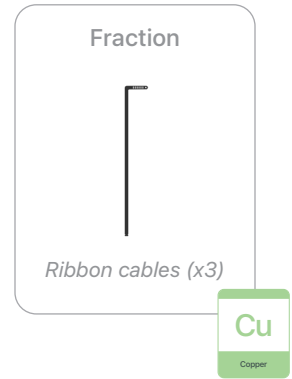
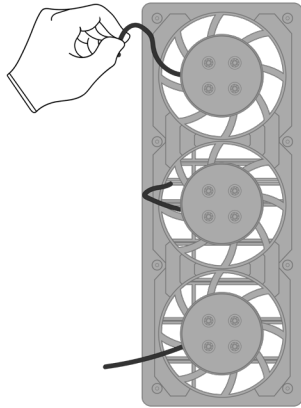



### 37. Pry the motor off each fan.

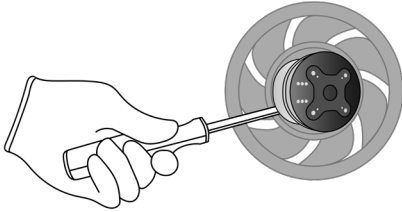

#### Tools Used



#### Fraction

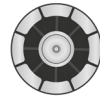

Fan motors (x3)

Cu

Copper

#### Fraction



Fans (x3)

PL

Plastics

### 38. Slide out the seven PCI slot covers.

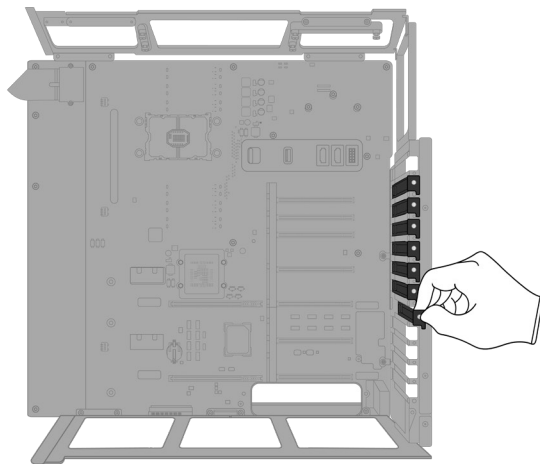

#### Fraction



Slot covers (x7)

Al

Aluminum

### 39. Remove the top I/O card cable.

» Remove the top I/O card cable cover by unscrewing the two Torx T5 fasteners.

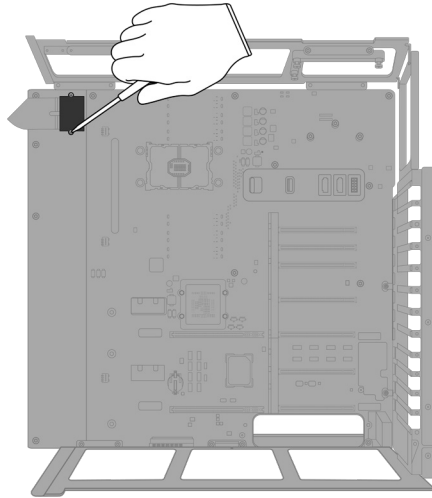

Tools Used

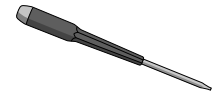

Fraction



Fasteners (x2)

Fe

Ferrous

Fraction



Top I/O card  
cable cover

Al

Aluminum

» Pull off the top I/O card cable by hand.

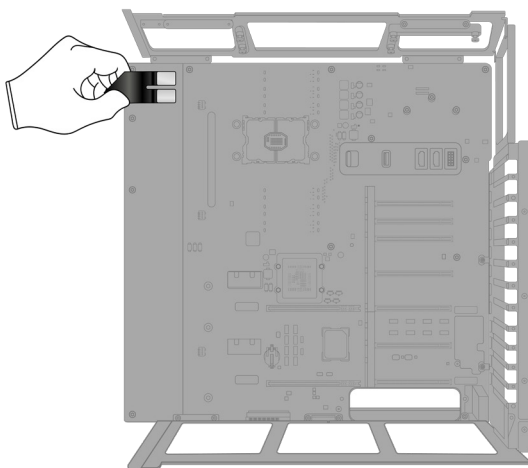

Fraction



Top I/O card  
cable

Cu

Copper

**40.** Remove the lower housing frame by unscrewing the five Torx T8 fasteners.

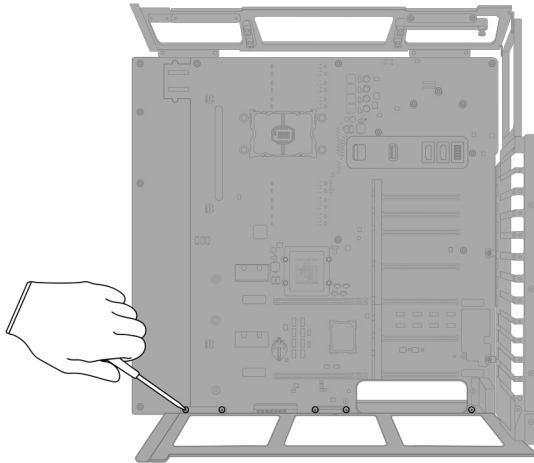

Tools Used

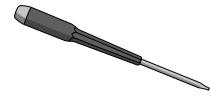

Fraction



Fasteners (x5)

Fe

Ferrous

Fraction



Lower housing frame

Al

Aluminum

# 41. Remove the side and upper housing frame.

» Unscrew the two Torx T8 fasteners.

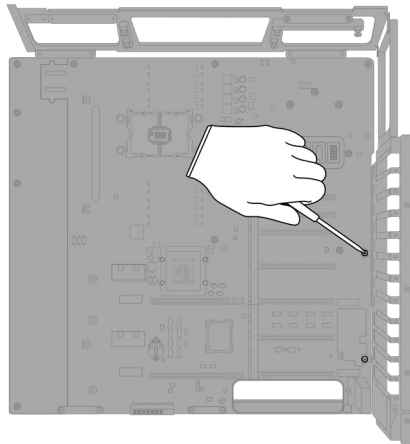

Tools Used

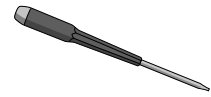

» Flip the assembly over and unscrew the four Torx T8 fasteners.

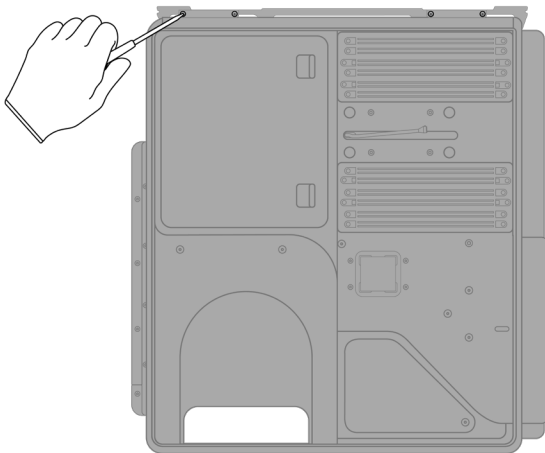

Fraction



Fasteners (x6)

Fe

Ferrous

Fraction



Side and upper housing frame

Al

Aluminum

**42.** Remove the heat channel by unscrewing the four Torx T8 fasteners.

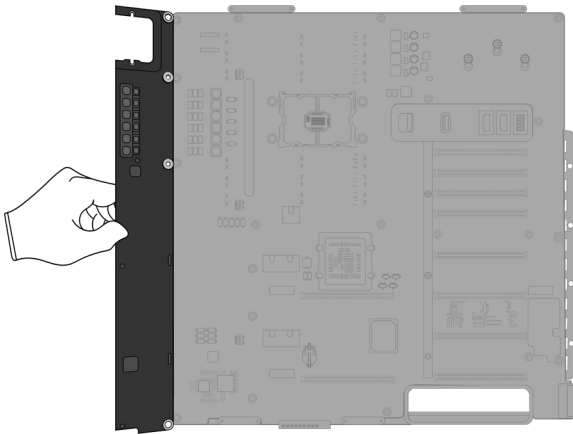
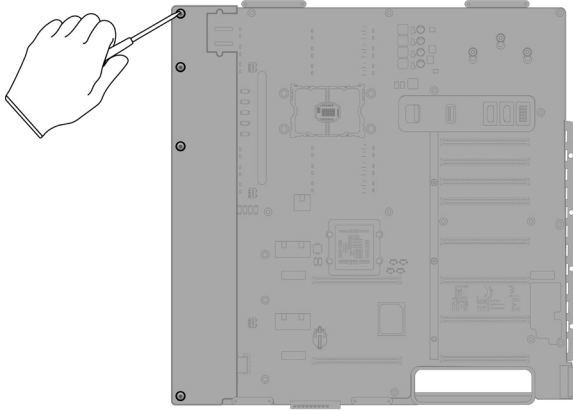

Tools Used

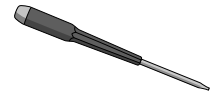

Fraction



Fasteners (x4)

Fe

Ferrous

Fraction



Heat channel

Al

Aluminum

### 43. Remove the back plate.

- » *Unscrew the 10 Torx T8 fasteners from the main logic board.*

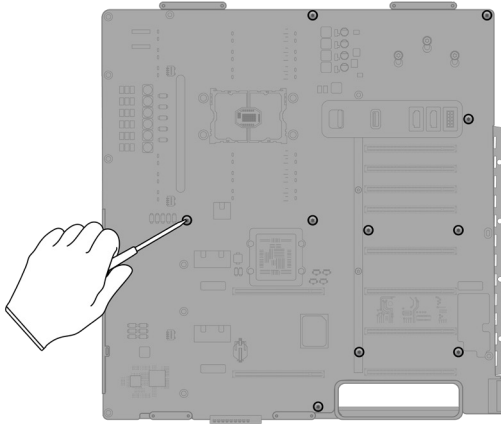

#### Tools Used

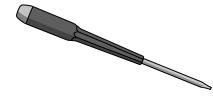

- » *Unscrew the three Torx T8 fasteners.*

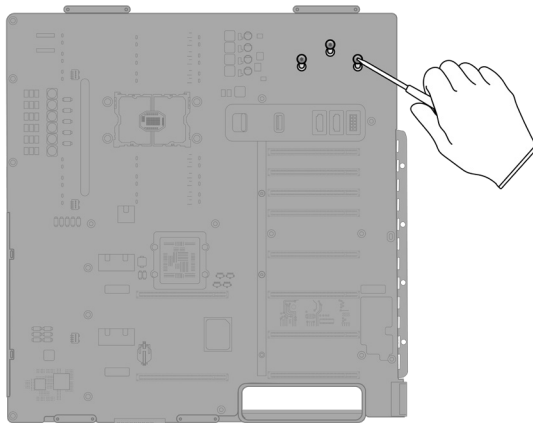

#### Fraction



*Fasteners (x13)*

**Fe**

Ferrous

» Pull the aluminum back plate from the main logic board.

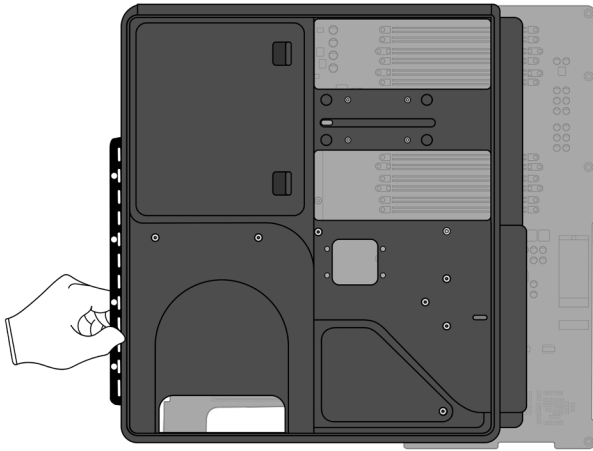

» Pull the plastic cover off the back plate.

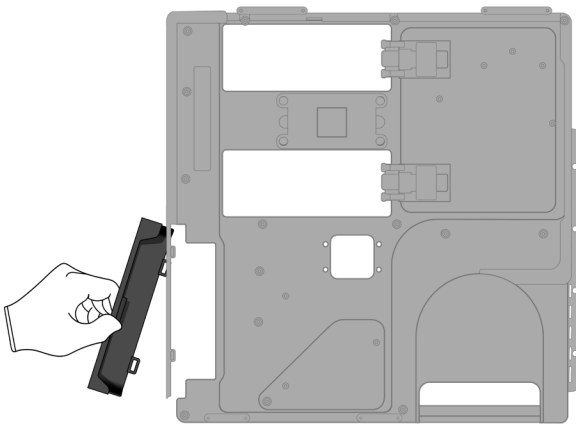

Fraction



Plastic cover

PL

Plastics

Fraction

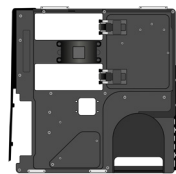

Back plate

Al

Aluminum



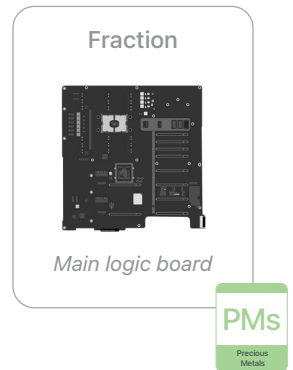
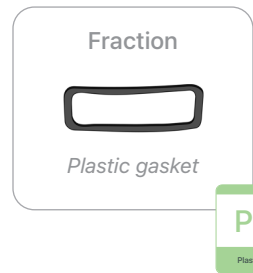
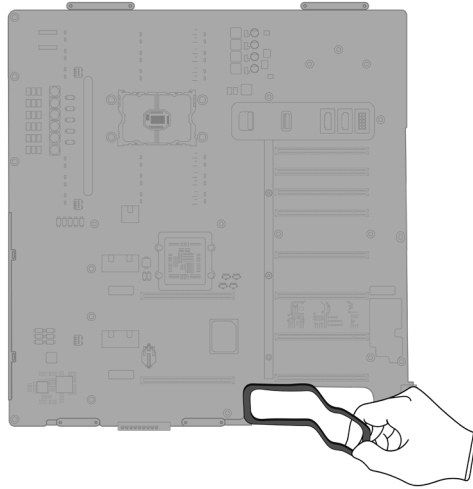



**44.** Remove the plastic gasket from the main logic board.



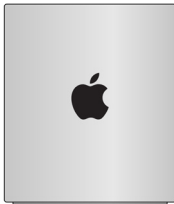

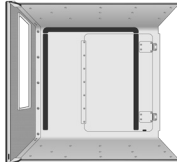
# Material Categorization of Output Fractions

All outputs from this process must be managed, handled, and disposed of in accordance with applicable waste laws and regulations, including but not limited to the Waste Framework Directive and its national enactments in Europe.

Fraction	Downstream Processing
<p data-bbox="435 604 570 632"><b>Aluminum</b></p>  <p data-bbox="451 905 553 930"><i>Top panel</i></p>  <p data-bbox="402 1157 597 1182"><i>Antenna covers (x2)</i></p>  <p data-bbox="444 1331 555 1356"><i>Front plate</i></p>  <p data-bbox="456 1583 544 1608"><i>Housing</i></p>	<p data-bbox="964 604 1276 632"><b>Primary Target Material</b></p>  <p data-bbox="924 831 1317 858"><b>Potential Additional Materials</b></p>  

Aluminum (cont.)

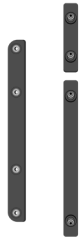

*Retaining brackets*

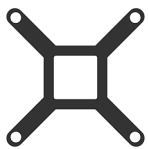

*Center bracket*



*Front face*

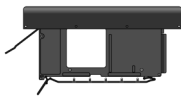

*GPU housing*

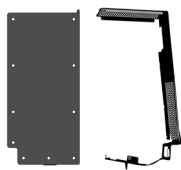

*Power supply enclosure*

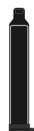

*Slot covers (x7)*

Aluminum (cont.)



*Top I/O card cable cover*



*Lower housing frame*



*Side and upper housing frame*



*Heat channel*

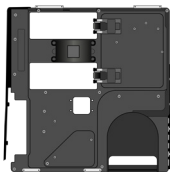

*Back plate*

**Fraction** **Downstream Processing**

**Batteries**



*Coin cell battery*

**Primary Target Material**



---

**Ferrous**



*Fasteners (x178)*



*Handles (x2)*



*Latch assemblies (x2)*



*Springs (x16)*



*Washer*

**Primary Target Material**



## Fraction

## Downstream Processing

### Logic Boards



*Power button logic board*



*Top I/O card*

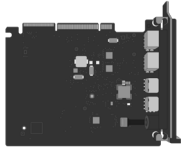

*I/O card*

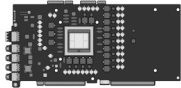

*GPU logic board*

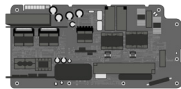

*Power supply logic board*



*Memory modules (x6)*

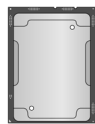

*Processor*

### Primary Target Material



### Potential Additional Materials



Logic Boards (cont.)



Main logic board

Mixed Electronics



Power cord



Antennas



Hall effect sensor

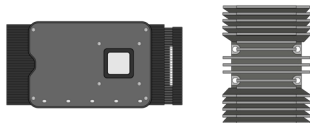

Heat sinks

Primary Target Material



Potential Additional Materials



**Mixed Electronics (cont.)**



*Power adapter*



*Thermal module*



*Blower*



*Ribbon cables (x3)*



*Fan motors (x3)*



*Top I/O card cable*

**Fraction**

**Downstream Processing**

**Mixed Plastics**



*Plastic sheets*



*Foam cushions*



*Mylar film*



*Memory module covers (x2)*



*Duct*

**Primary Target Material**





Mixed Plastics (cont.)

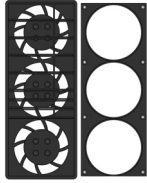

Fan assembly



Fans (x3)



Plastic cover



Plastic gasket

Rare Earth Magnets



Speaker

Primary Target Material



Potential Additional Materials

