



iMac Pro (2017)

Apple Recycler Guide

May 2023

Contents

3	About This Guide
4	Identification
5	Directive 2012/19/EU Annex VII Components
6	Safety Considerations
7	Recommended Tools
8	Disassembly Instructions
32	Material Categorization of Output Fractions

About This Guide

Apple Recycler Guides provide guidance for electronics recyclers on how to disassemble products to maximize recovery of resources. The guides provide step-by-step disassembly instructions and information on the material composition to help recyclers direct fractions to the appropriate material recycler.

To conserve important resources, we work to reduce the materials we use and aim to one day source only recycled or renewable materials in our products. A key path to reaching that goal is resource recovery from end-of-life electronics.

Disassembly procedures are intended to be performed only by trained electronics recycling professionals. The recycler is responsible for independently evaluating and ensuring compliance with all applicable environmental, health, and safety laws related to the work. These include but are not limited to laws relating to the management, handling, shipping, and disposal of the outputs of this work as waste and laws in place to ensure the health and safety of all employees who support this work.

For questions or feedback about this guide, email contactesci@apple.com.

Identification

You can find the model number of the iMac Pro on the bottom of the stand.



Model number:
A1862

Directive 2012/19/EU Annex VII Components

Directive 2012/19/EU Annex VII requirements apply to the following substances and components.

Substance/Component	Apple Part Name	Removal Instructions
Printed circuit board if the surface is greater than 10 square centimeters	Display logic board, light-emitting diode (LED) logic board, main logic board, power supply logic board	Follow steps 1–19
External electric cables	Power cord	Follow step 1
Battery	Coin cell battery	Follow steps 1–16
Cover glass and liquid crystal display (LCD) cell if the surface is greater than 100 square centimeters	LCD cell	Follow steps 1–10
No further substances or components as listed in Annex VII		

Safety Considerations

The recycler is responsible for independently evaluating all activities undertaken by its employees to perform or support the work and ensuring compliance with all applicable health and safety laws related to the work. These include but are not limited to laws relating to the health and safety of all employees who perform or support this work. The recycler is also responsible for evaluating the workspace and ensuring that the area in which the work is to be undertaken is designed using ergonomic best practices and meets all ergonomic requirements to ensure the protection of its employees.

Personal Protective Equipment

Personal protective equipment should be worn during the entire recycling process.



Wear hand protection



Wear a mask



Wear eye protection



Wear foot protection



Wear protective clothing

LED Safety

Broken LEDs must be handled properly to ensure the safety of your employees and mitigate any hazards. Package broken LEDs in an appropriate container to properly manage the hazards associated with the materials and store only with compatible materials. All waste must be properly classified, packaged, and labeled in accordance with all relevant laws and regulations.

Hazard Warnings



Broken glass hazard



Chemical inhalation hazard



Chemical exposure hazard

Recommended Tools

Miniature pry bar

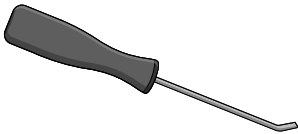

Nail-pulling screwdriver

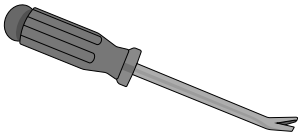

Phillips screwdriver

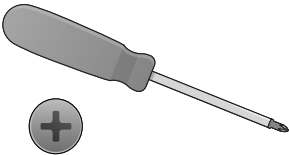

Screwdriver-handle pry bar

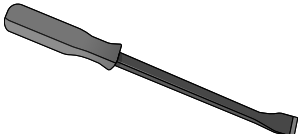

Torx T8 screwdriver

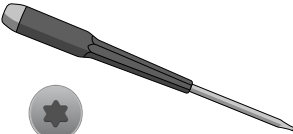

Wire cutters

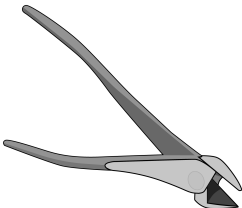

Disassembly Instructions

1. Remove the power cord.

» *Ensure that the iMac Pro is turned off.*



» *Unplug the power cord from the back of the iMac Pro.*

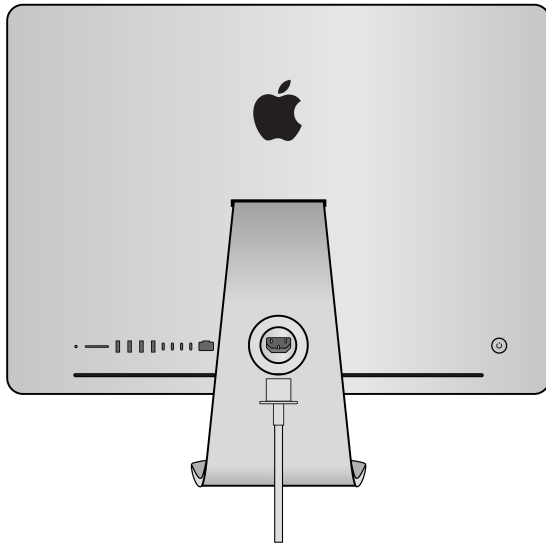

Warning: Before continuing disassembly, wait 10 minutes after unplugging the device for stored energy to discharge.

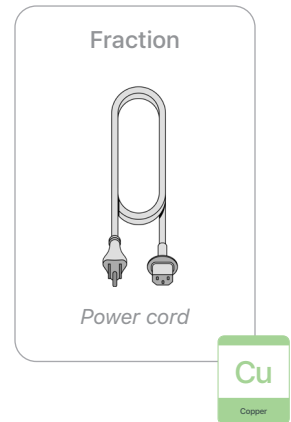

2. Pry away the display from the housing.



Broken glass hazard

Tools Used

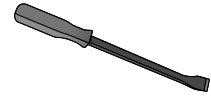

3. Separate the display from the housing.

» *Disconnect the wires.*

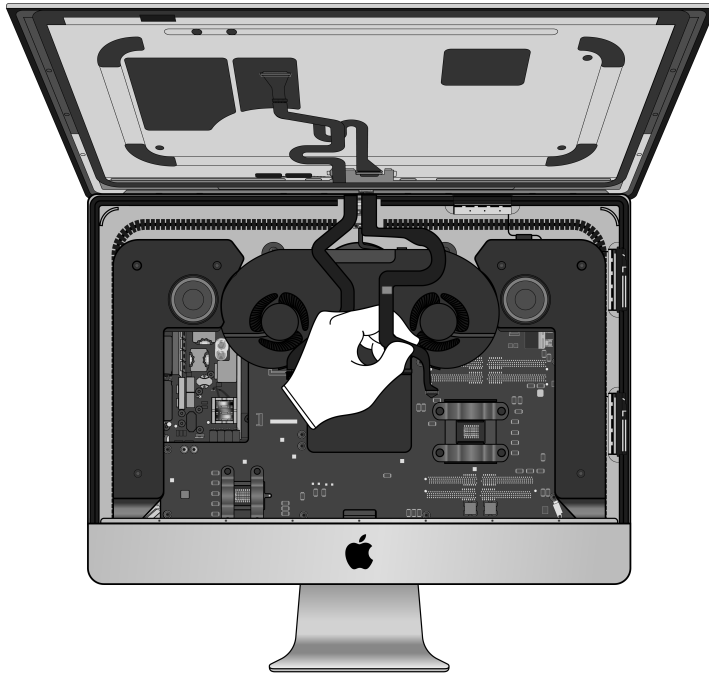

» *Lay the display face down. Set the housing aside.*

4. Pull the ribbon cables off the back of the display.

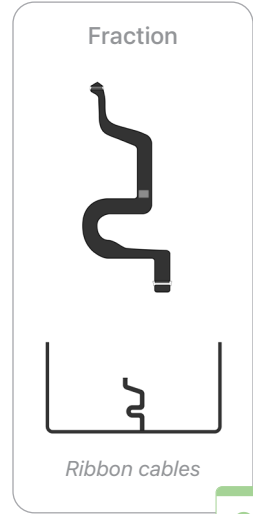
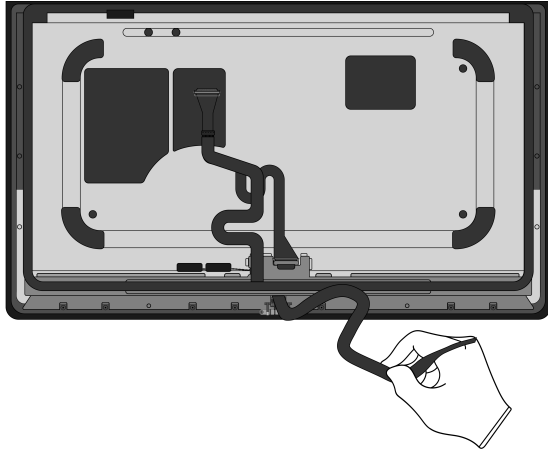

Fraction

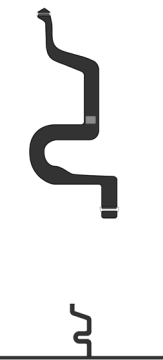

Ribbon cables

Cu
Copper

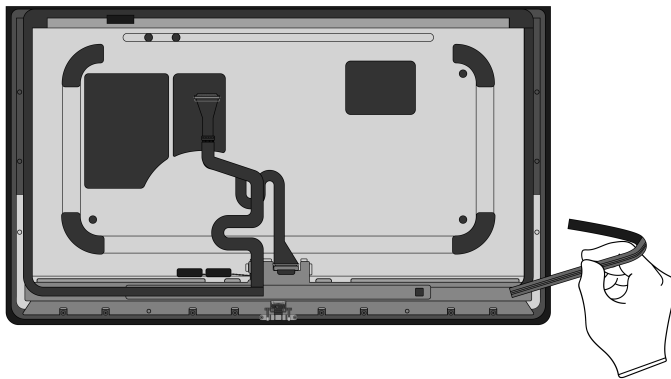

5. Remove the camera with logic board.

» *Pry off the logic board cover.*

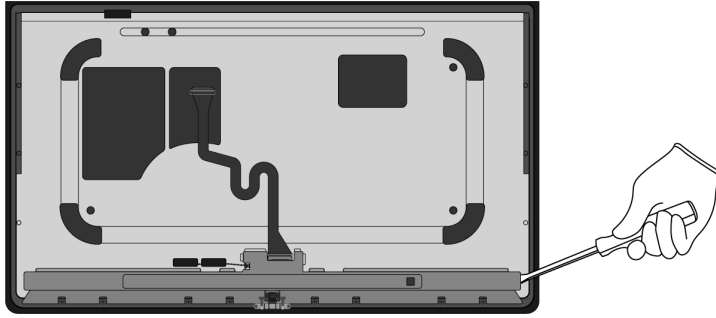

Tools Used

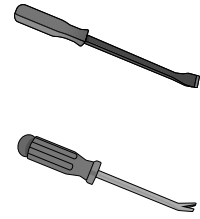

» *Pry the camera with logic board off the logic board cover.*

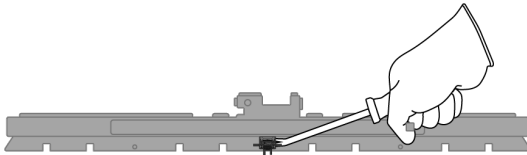

Fraction



Logic board cover

Fe

Ferrous

Fraction



Camera with logic board

PMs

Precious Metals

6. Pull the ribbon cable off the display logic board.

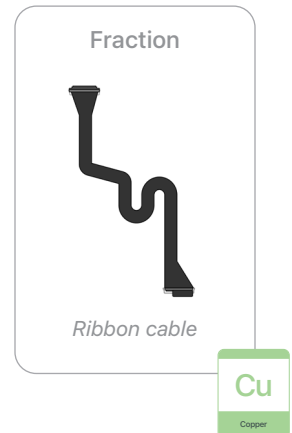
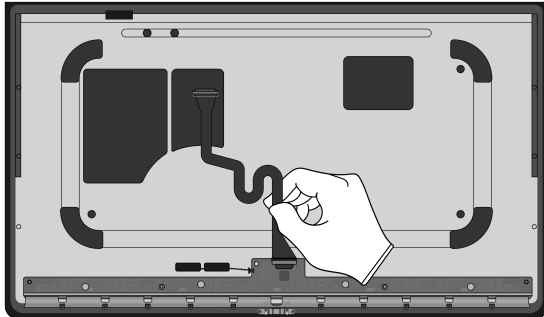

7. Pry off the display logic board.

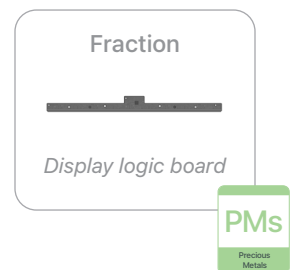
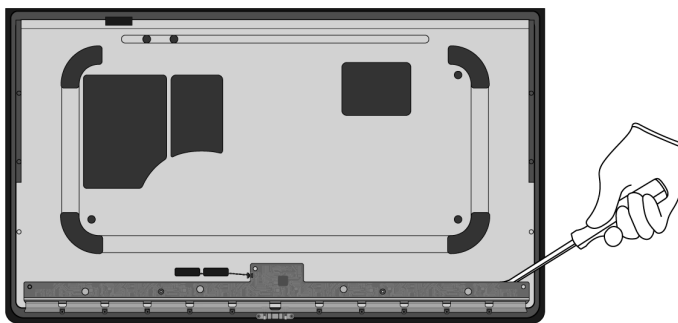

8. Pull off the flex cable.

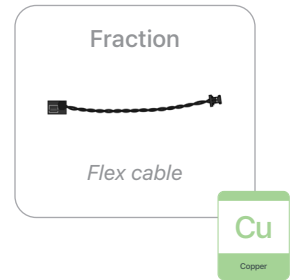
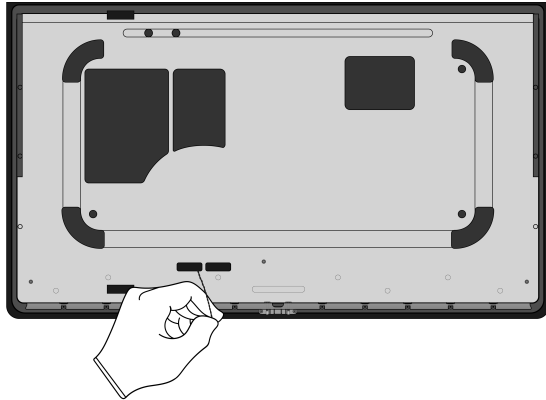

9. Pry off the mid plate. Then set the mid plate aside.

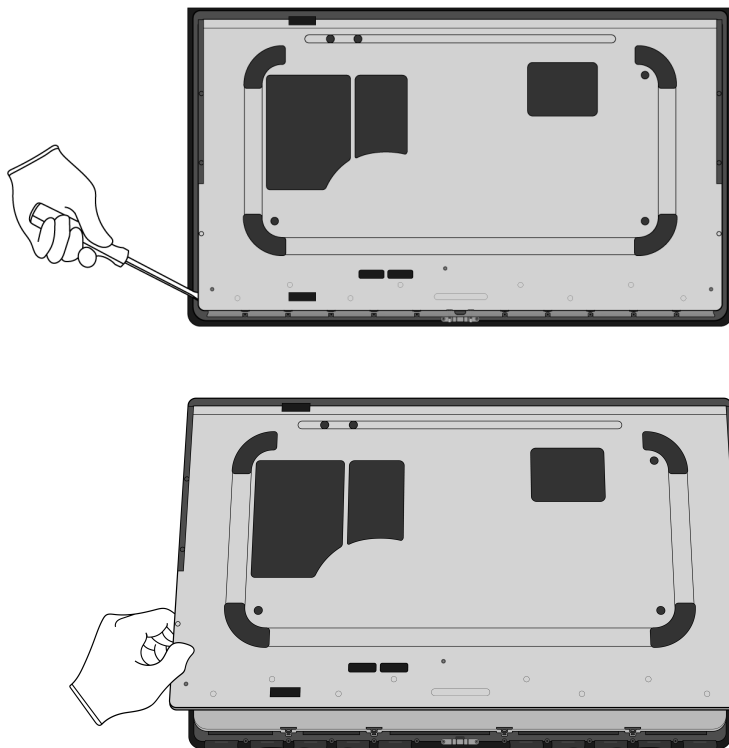

10. Pry the display films off the LCD cell.



Chemical exposure hazard

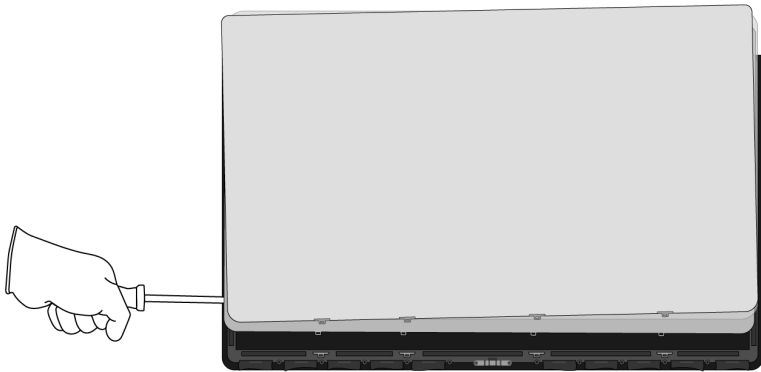

Tools Used

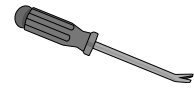

Fraction



Display films

PL

Plastics

Fraction



LCD cell

GL

Glass

11. Separate the LED logic board and the mid plate.

» *Unscrew the 16 Phillips fasteners.*

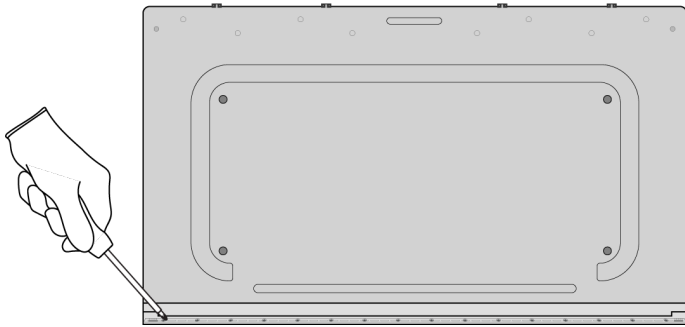

Tools Used

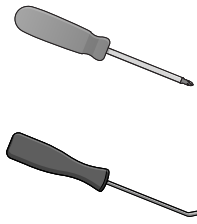

Fraction



Fasteners (x16)

Fe

Ferrous

» Pry off the LED logic board and the LED cover.

 Chemical inhalation hazard

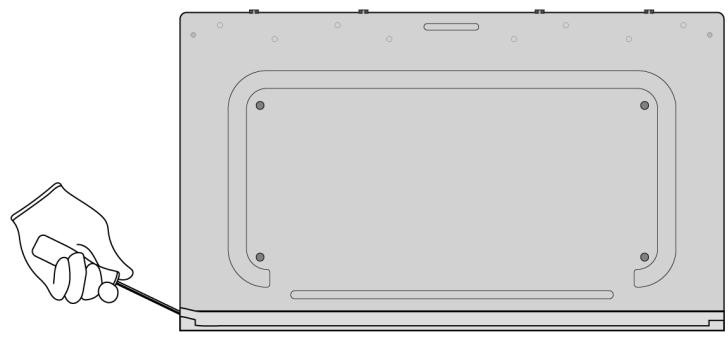
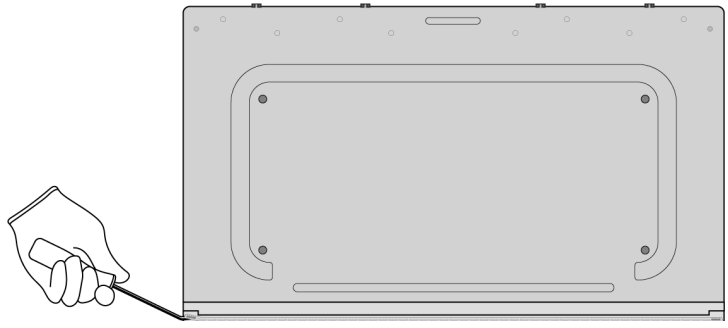

Fraction

LED logic board

PMs
Precious Metals

Fraction

LED cover

PL
Plastics

Fraction

Mid plate

Al
Aluminum

12. Pry the left speaker off the housing.

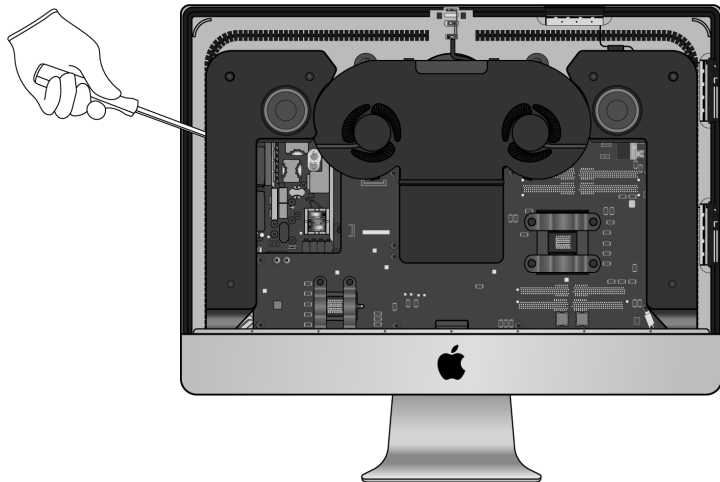

Tools Used



Fraction



Left speaker

REE

Rare Earth
Elements

13. Pry off the dual fan.

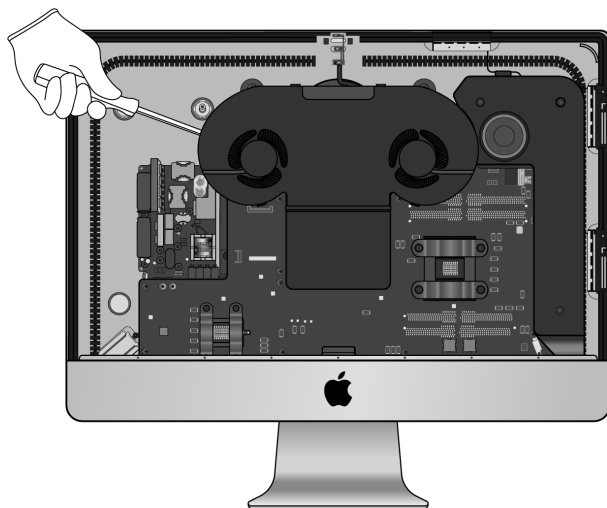

Tools Used



Fraction



Dual fan

Cu

Copper

14. Pry off the right speaker.

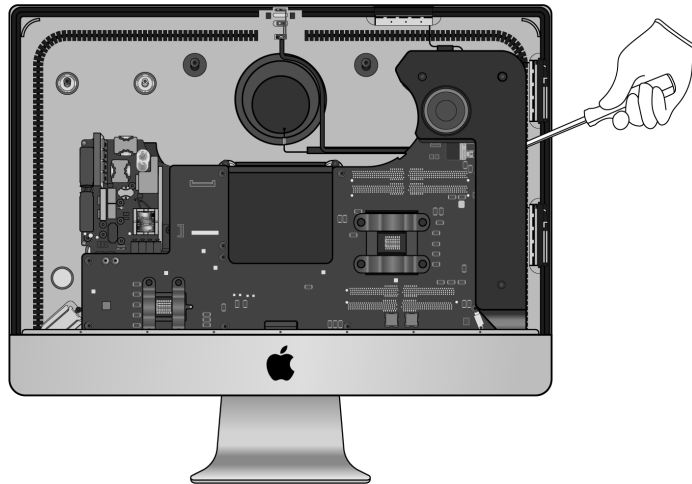

Tools Used



Fraction



Right speaker

REE

Rare Earth
Elements

15. Remove the main logic board.

» *Unscrew the 10 Torx T8 fasteners.*

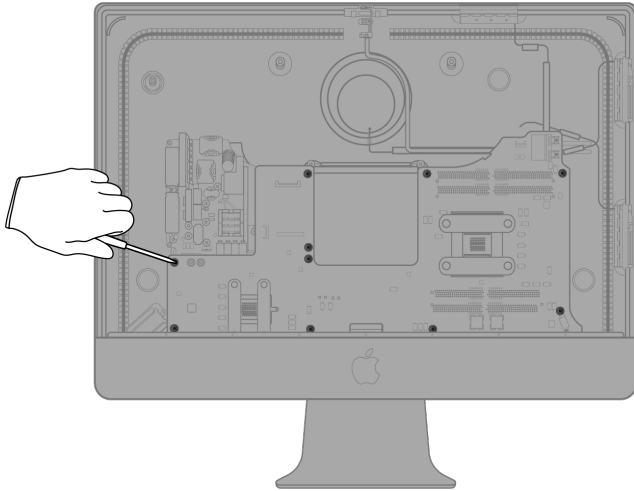

Tools Used

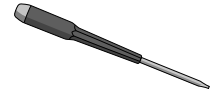

Fraction



Fasteners (x10)

Fe

Ferrous

» *Pull out the main logic board. Set the housing aside.*

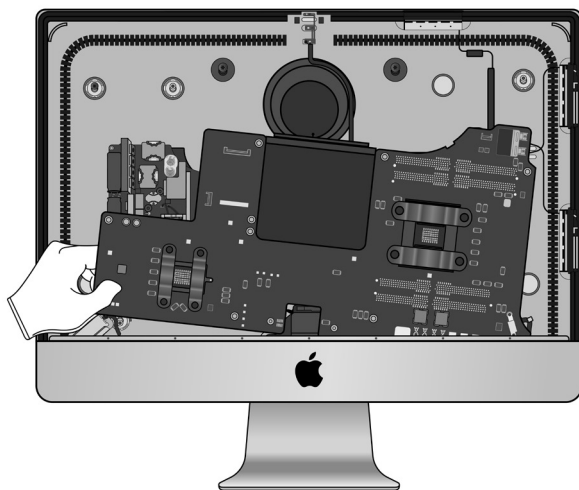

16. Remove the coin cell battery.

» Pry the coin cell battery enclosure off the main logic board.

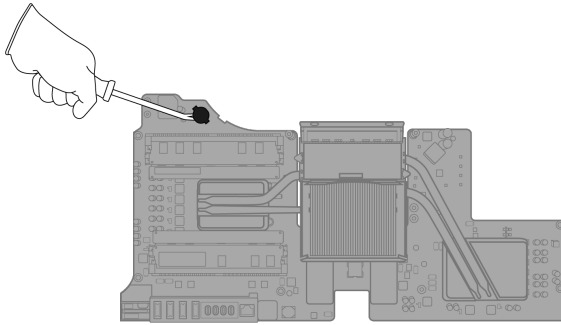

Tools Used

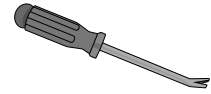

» Pry the coin cell battery off the coin cell battery enclosure.

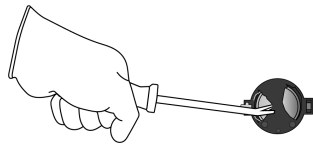

Fraction

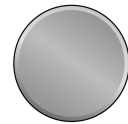

Coin cell battery

BT

Battery

Fraction



Coin cell battery enclosure

Cu

Copper

- 17.** Flip over the main logic board and pry off the eight fastener covers.

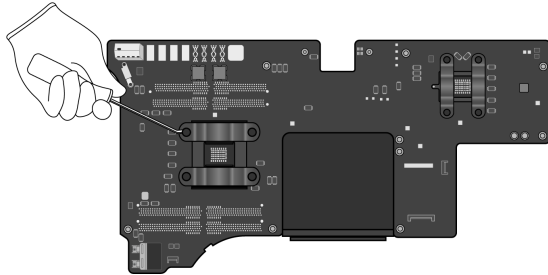

Tools Used

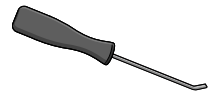

Fraction



Fastener covers (x8)

PL

Plastics

18. Remove the heat sink.

- » Remove the heat sink brackets by unscrewing the eight Torx T8 fasteners.

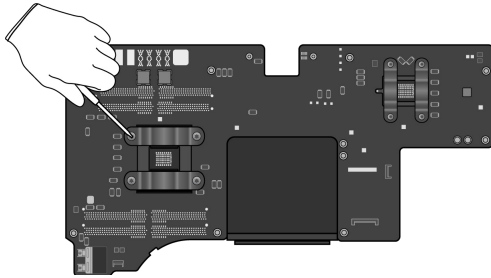

- » Flip over the main logic board and pull off the heat sink by hand.

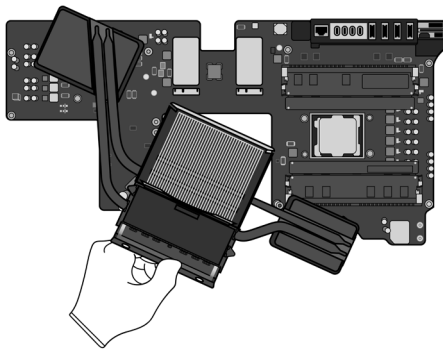

Tools Used

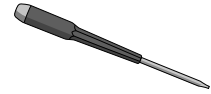

Fraction



Fasteners (x8)

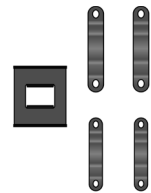

Heat sink brackets

Fe

Ferrous

Fraction

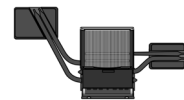

Heat sink

Cu

Copper

Fraction

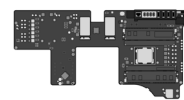

Main logic board

PMs

Precious Metals

19. Remove the power supply logic board.

» *Pry off the power supply logic board.*

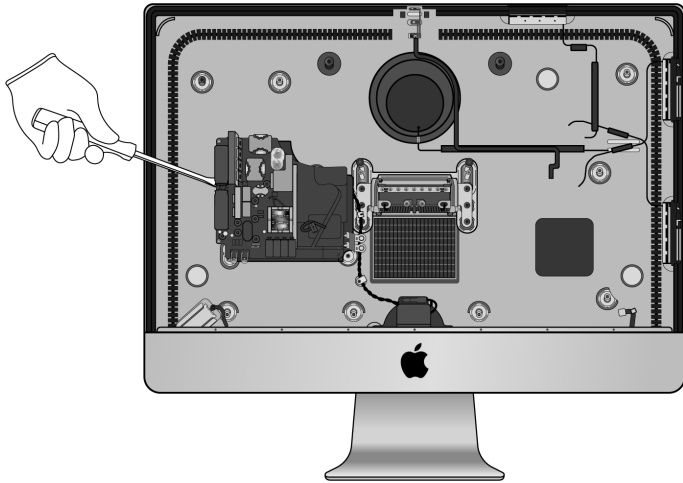

Tools Used

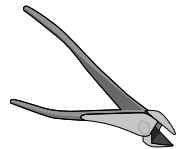

Fraction

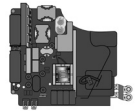

*Power supply
logic board*

PMs
Precious
Metals

» *Cut the cable connected to the power connector.*

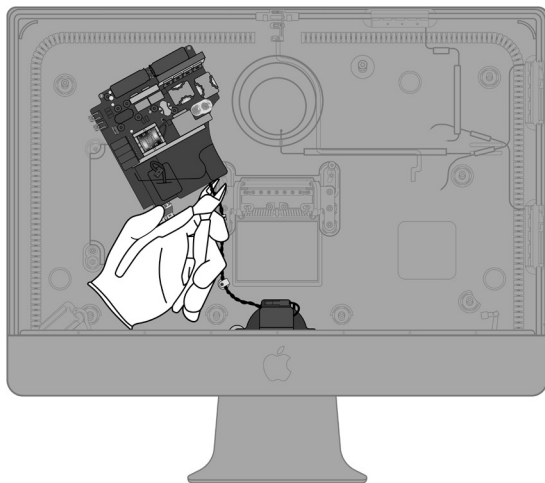

20. Remove the microphone.

» Pull off the microphone cable by hand.

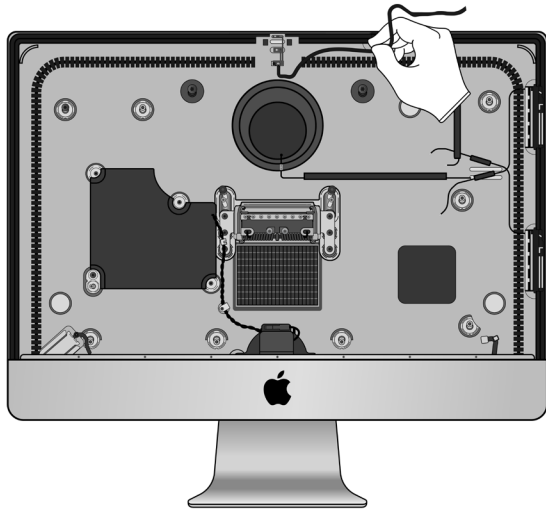

Tools Used



Fraction

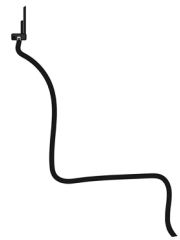

Microphone cable

Cu

Copper

» Pry off the microphone.

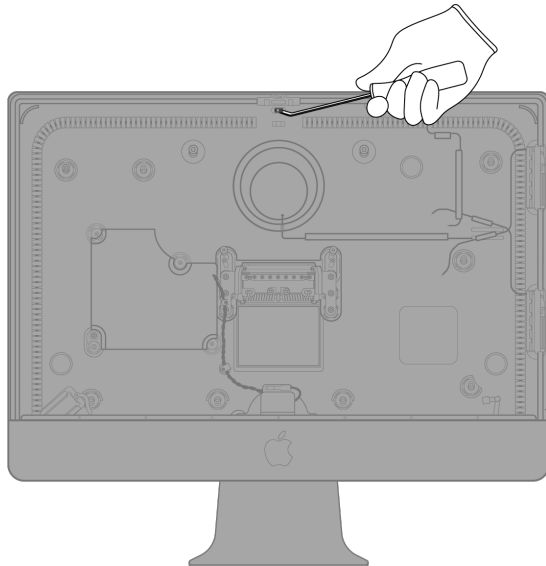

Fraction



Microphone

Cu

Copper

21. Pry off the three Wi-Fi antennas.

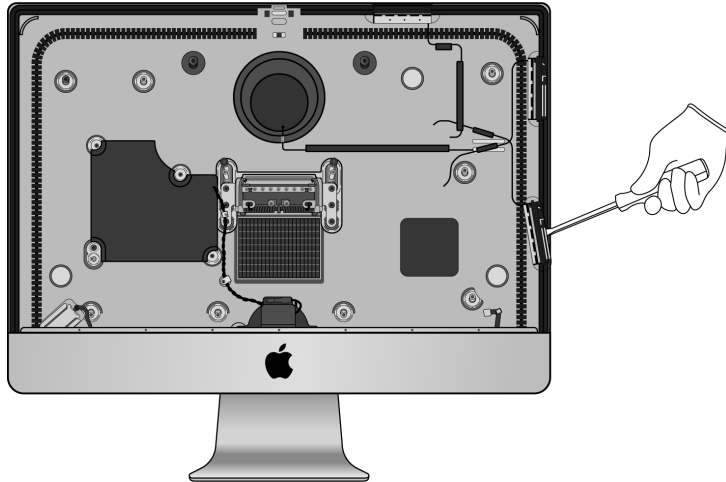

Tools Used

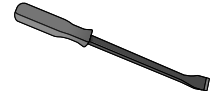

Fraction



Wi-Fi antennas

Cu

Copper

22. Pry off the Bluetooth antenna.

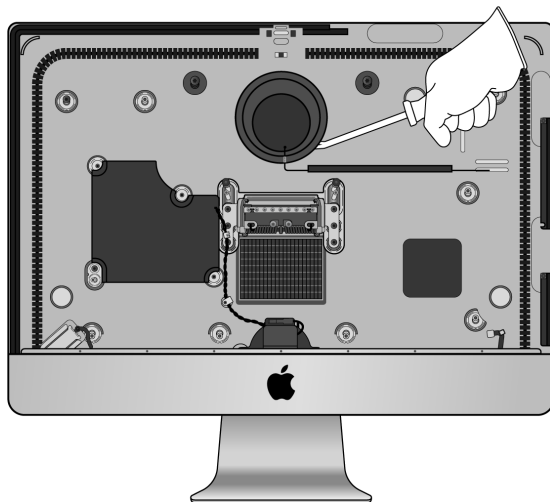

Tools Used

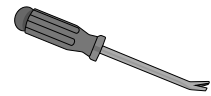

Fraction



Bluetooth antenna

Cu

Copper

- 23.** Pry off the brackets that hold the power connector cable to the housing.

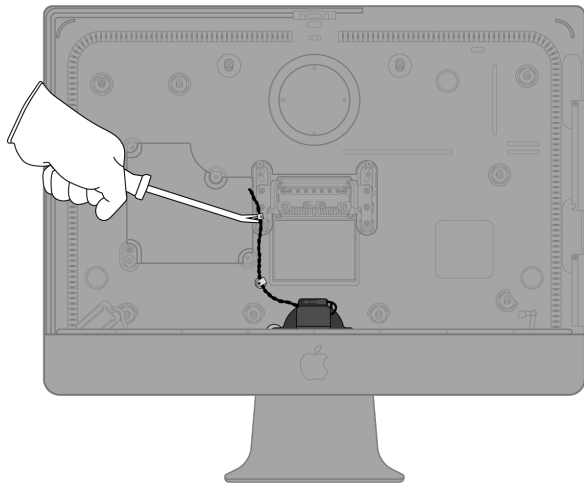

Tools Used

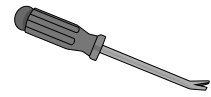

24. Remove the stand from the hinge by unscrewing the nine Torx T8 fasteners.

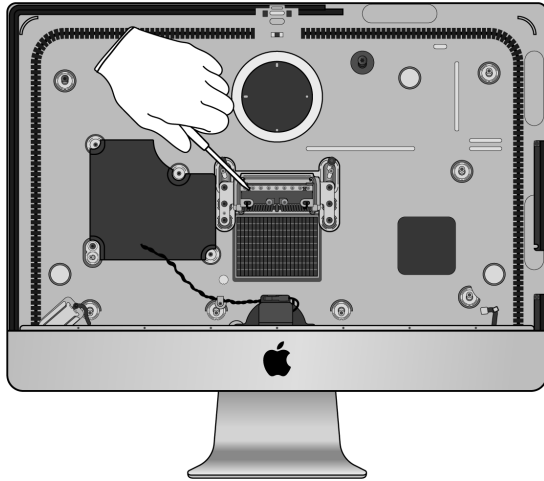

Tools Used

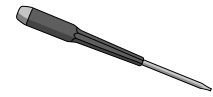

Fraction



Fasteners (x9)

Fe

Ferrous

Fraction



Stand

Al

Aluminum

- 25.** Remove the hinge from the housing by unscrewing the six Torx T8 fasteners.

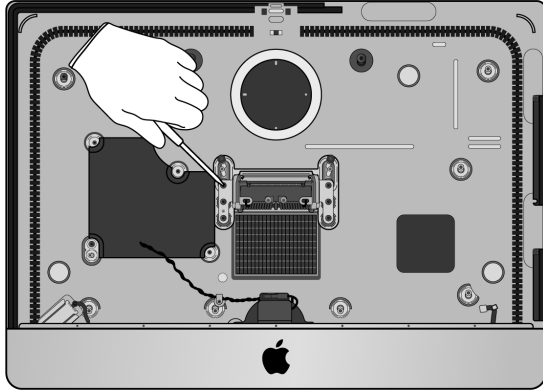

Tools Used

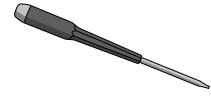

Fraction



Fasteners (x6)

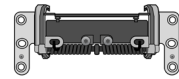

Hinge

Fe

Ferrous

26. Remove the power connector.

- » *Rotate the housing upside down to access the power connector.*
- » *Pry off the power connector.*

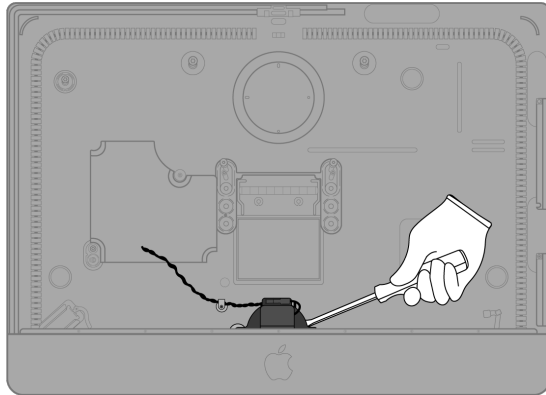

Tools Used

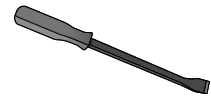

Fraction



Power connector

Cu

Copper

27. Pry off the headphone jack.

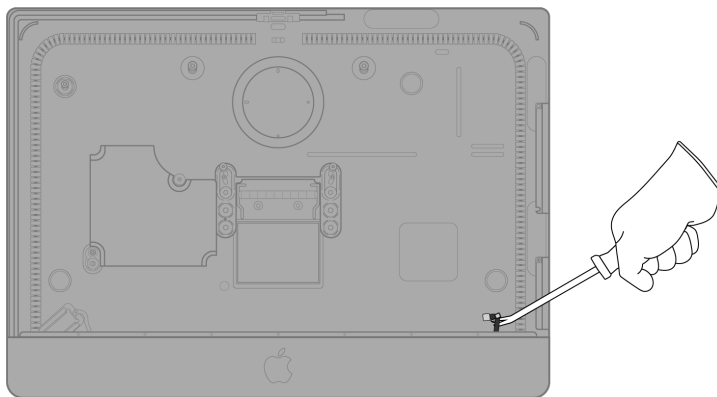

Tools Used

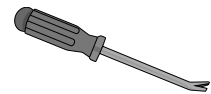

Fraction

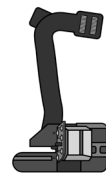

Headphone jack

Cu

Copper

28. Pry off the power button.

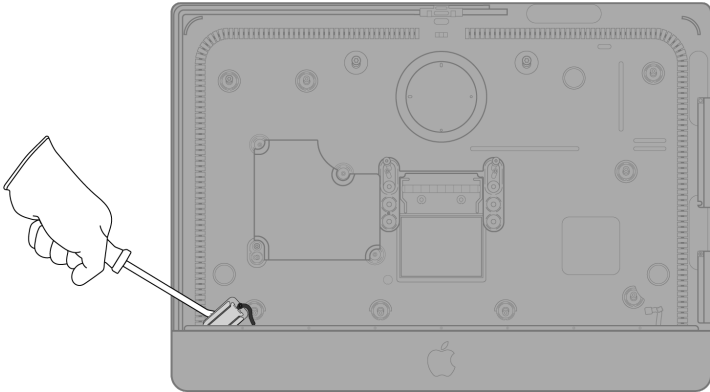

Tools Used

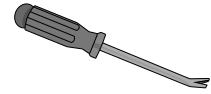

Fraction

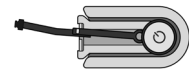

Power button

Cu
Copper

Fraction

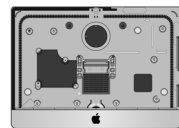

Housing

Al
Aluminum

Material Categorization of Output Fractions

All outputs from this process must be managed, handled, and disposed of in accordance with applicable waste laws and regulations, including but not limited to the Waste Framework Directive and its national enactments in Europe.

Fraction	Downstream Processing
----------	-----------------------

Aluminum



Mid plate

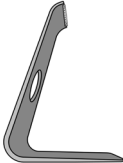

Stand

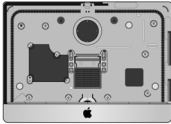

Housing

Primary Target Material



Potential Additional Material



Batteries

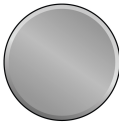

Coin cell battery

Primary Target Material



Fraction

Downstream Processing

Ferrous

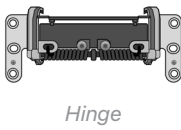
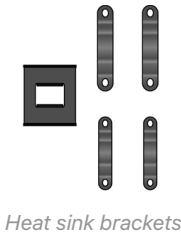
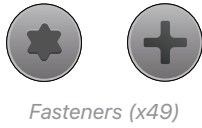

Primary Target Material



Glass

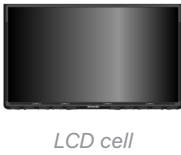

Primary Target Material



Potential Additional Materials



Fraction

Downstream Processing

Logic Boards



Camera with logic board



Display logic board



LED logic board

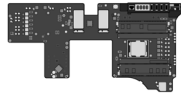

Main logic board

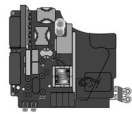

Power supply logic board

Primary Target Material



Potential Additional Materials



Fraction

Downstream Processing

Mixed Electronics

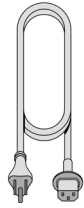

Power cord

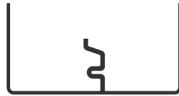

Ribbon cables



Flex cable

Primary Target Material



Potential Additional Materials



Mixed Electronics (cont.)



Dual fan

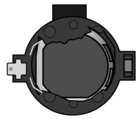

Coin cell battery enclosure

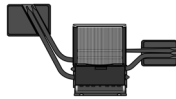

Heat sink

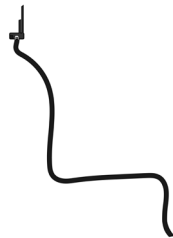

Microphone cable



Microphone

Mixed Electronics (cont.)



Wi-Fi antennas



Bluetooth antenna



Power connector

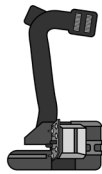

Headphone jack

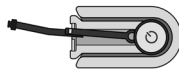

Power button

Fraction

Downstream Processing

Mixed Plastics



Display films



LED cover



Fastener covers

Primary Target Material



Rare Earth Magnets



Left speaker



Right speaker

Primary Target Material



Potential Additional Materials

