



# HomePod (2<sup>nd</sup> generation)

## Apple Recycler Guide

May 2023

# Contents

3	<a href="#">About This Guide</a>
4	<a href="#">Identification</a>
5	<a href="#">Directive 2012/19/EU Annex VII Components</a>
6	<a href="#">Safety Considerations</a>
7	<a href="#">Recommended Tools</a>
8	<a href="#">Disassembly Instructions</a>
26	<a href="#">Material Categorization of Output Fractions</a>

# About This Guide

Apple Recycler Guides provide guidance for electronics recyclers on how to disassemble products to maximize recovery of resources. The guides provide step-by-step disassembly instructions and information on the material composition to help recyclers direct fractions to the appropriate material recycler.

To conserve important resources, we work to reduce the materials we use and aim to one day source only recycled or renewable materials in our products. A key path to reaching that goal is resource recovery from end-of-life electronics.

Disassembly procedures are intended to be performed only by trained electronics recycling professionals. The recycler is responsible for independently evaluating and ensuring compliance with all applicable environmental, health, and safety laws related to the work. These include but are not limited to laws relating to the management, handling, shipping, and disposal of the outputs of this work as waste and laws in place to ensure the health and safety of all employees who support this work.

For questions or feedback about this guide, email [contactesci@apple.com](mailto:contactesci@apple.com).

# Identification

You can find the model number on the bottom of the HomePod (2<sup>nd</sup> generation).

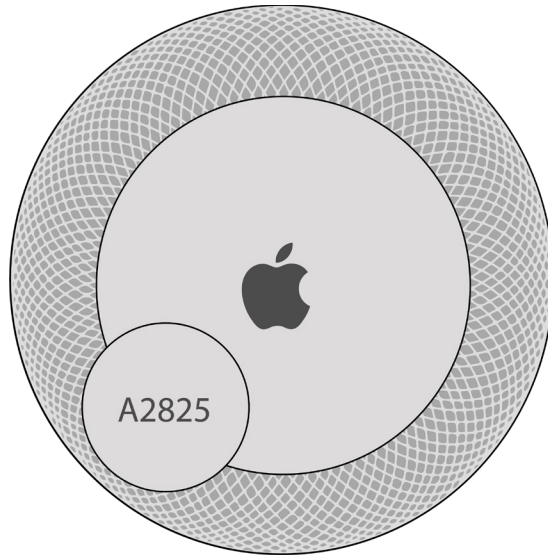

*Model number:*  
A2825

# Directive 2012/19/EU Annex VII Components

Directive 2012/19/EU Annex VII requirements apply to the following substances and components.

Substance/Component	Apple Part Name	Removal Instructions
Printed circuit board if the surface is greater than 10 square centimeters	Main logic board, power supply logic board	Follow steps 1–14
External electric cables	Power cord	Follow step 1
No further substances or components as listed in Annex VII		

# Safety Considerations

The recycler is responsible for independently evaluating all activities undertaken by its employees to perform or support the work and ensuring compliance with all applicable health and safety laws related to the work. These include but are not limited to laws relating to the health and safety of all employees who perform or support this work. The recycler is also responsible for evaluating the workspace and ensuring that the area in which the work is to be undertaken is designed using ergonomic best practices and meets all ergonomic requirements to ensure the protection of its employees.

## Personal Protective Equipment

Personal protective equipment should be worn during the entire recycling process.



Wear eye protection



Wear protective clothing



Wear hand protection



Wear foot protection

## Hazard Warning



Broken glass hazard

# Recommended Tools

Miniature pry bar

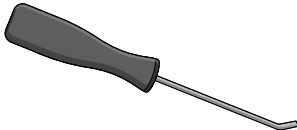

Nail-pulling screwdriver

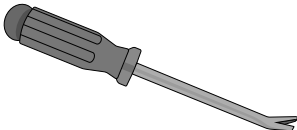

Screwdriver-handle pry bar

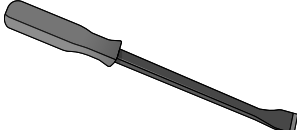

Torx T4 screwdriver

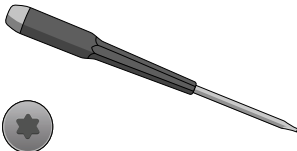

Torx T6 screwdriver

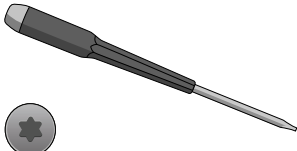

Utility knife

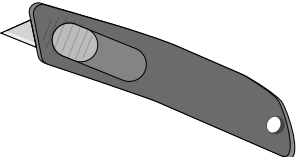

# Disassembly Instructions

1. Disconnect the power cord.

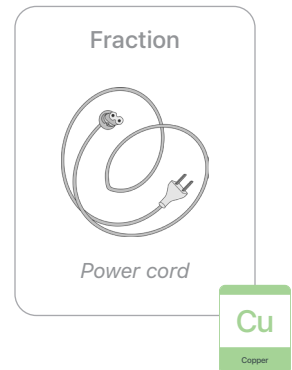
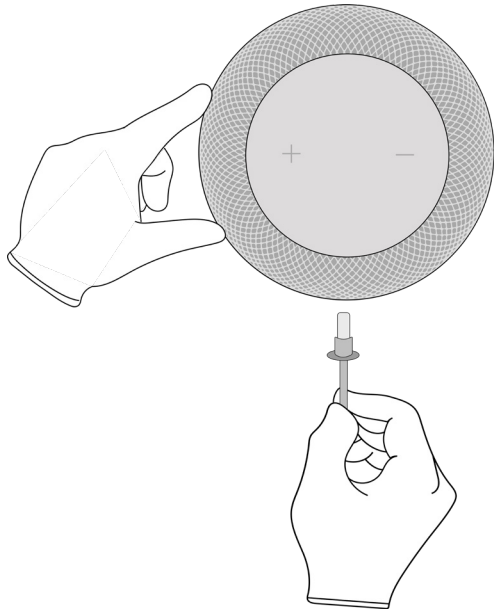

**Warning:** Before continuing disassembly, wait 10 minutes after unplugging the device for stored energy to discharge.



2. With the bottom of the HomePod facing up, pry off the base.

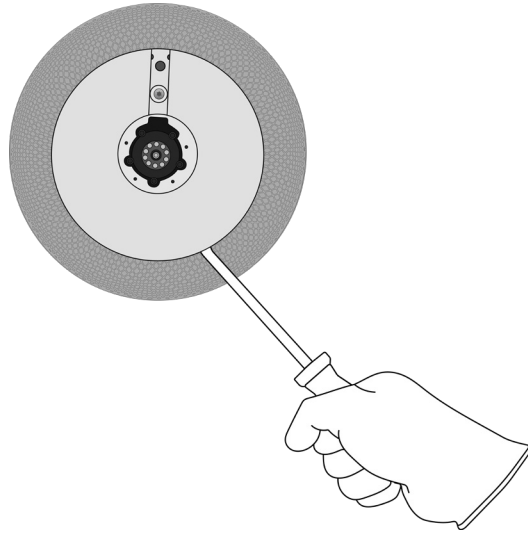

Tools Used

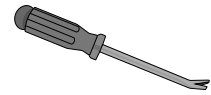

Fraction

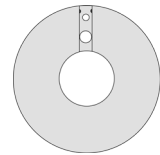

Base

PL

Plastics

### 3. Remove the fabric anchor.

» Unscrew the five Torx T6 fasteners.

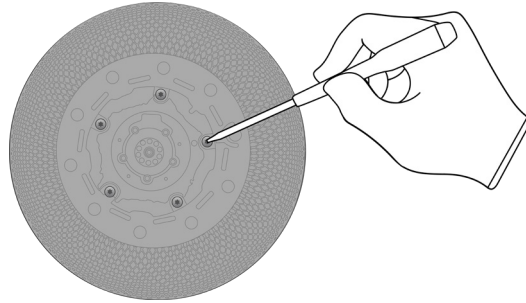

Tools Used

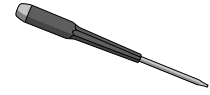

Fraction



Fasteners (x5)

Fe

Ferrous

» Pull off the fabric anchor flange by hand.

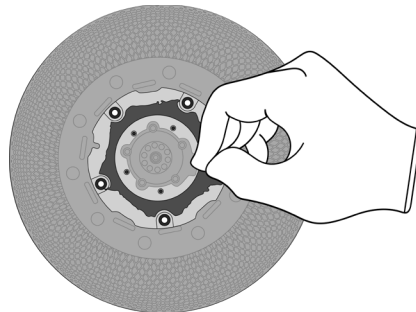

Fraction



Fabric anchor flange

PL

Plastics

» Pull off the fabric anchor.

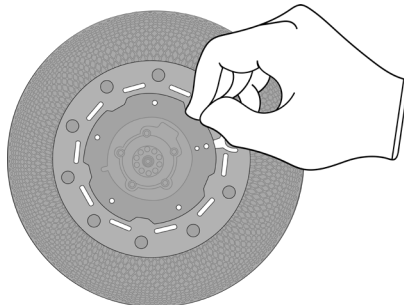

Fraction

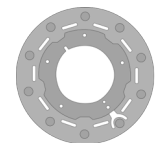

Fabric anchor

Fe

Ferrous

- 4.** Cut all around the fabric module cover to loosen it.

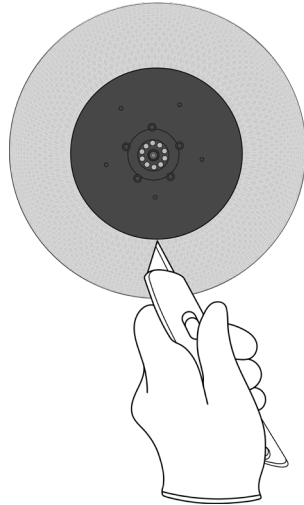

Tools Used

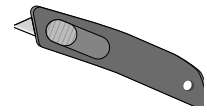

- 5.** Flip the HomePod. Lift the fabric module cover to expose the enclosure.

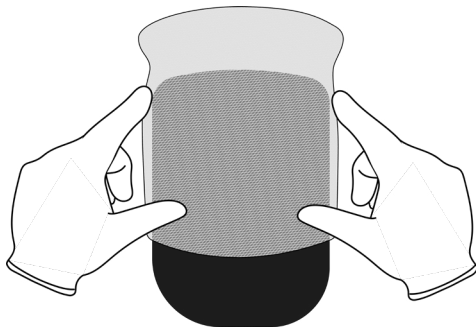

## 6. Remove the upper ring.

» *Pry off the eight fastener covers.*

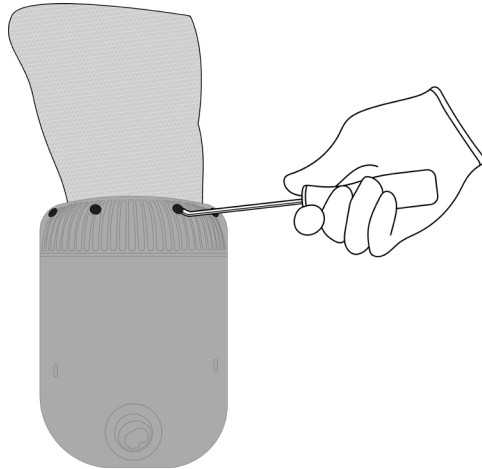

» *Unscrew the eight Torx T6 fasteners.*

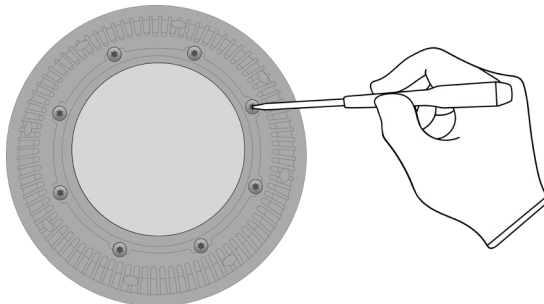

### Tools Used

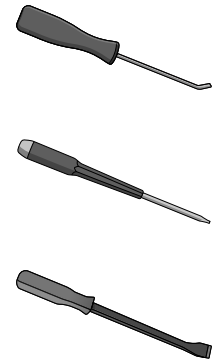

### Fraction



Fastener covers (x8)

PL

Plastics

### Fraction



Fasteners (x8)

Fe

Ferrous

- » *Using the screwdriver-handle pry bar, pry off the upper ring. Set the enclosure aside.*

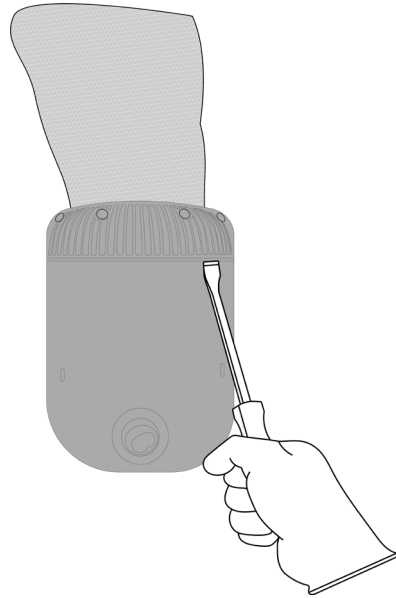

## 7. Remove the main logic board.

» Inside the upper ring, unscrew the four Torx T6 fasteners.

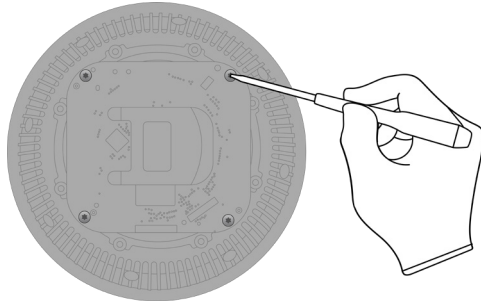

### Tools Used

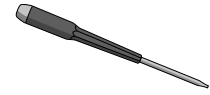

### Fraction



Fasteners (x4)

Fe

Ferrous

» Pull out the main logic board by hand.

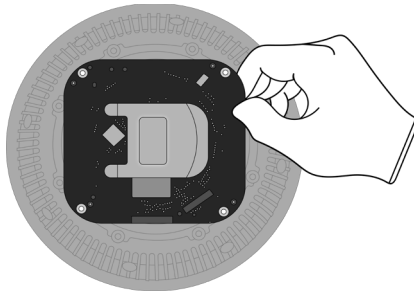

### Fraction

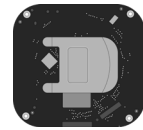

Main logic board

PMs

Precious Metals

8. Remove the touch sensor.

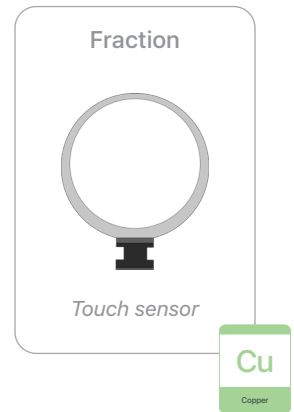
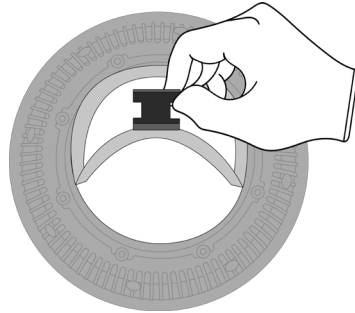

## 9. Remove the touch assembly.



Broken glass hazard

» Unscrew the eight Torx T6 fasteners.

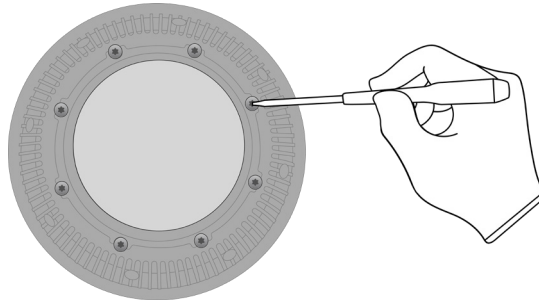

Tools Used

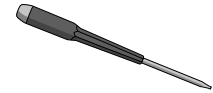

Fraction



Fasteners (x8)

Cu

Copper

» Pull out the touch assembly by hand.

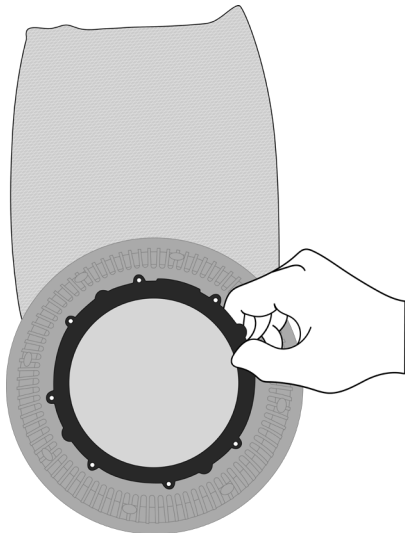

Fraction

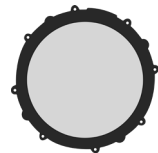

Touch assembly

GL

Glass



# 10. Pry off the fabric module cover.

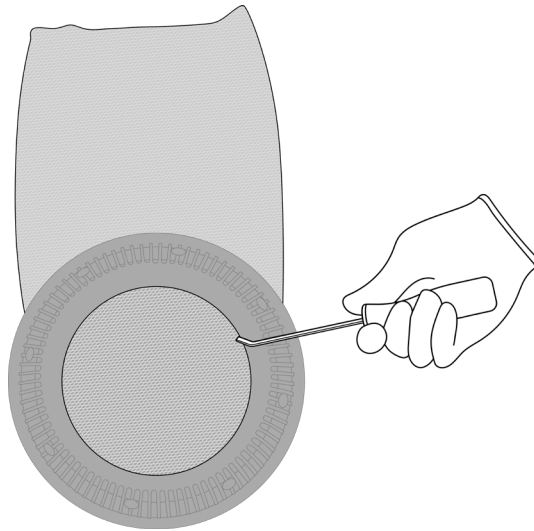

## Tools Used



## Fraction

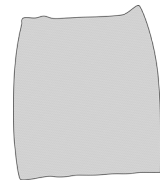

Fabric module cover

PL

Plastics

## Fraction



Upper ring

PL

Plastics

**11.** Pry the woofer out of the enclosure.

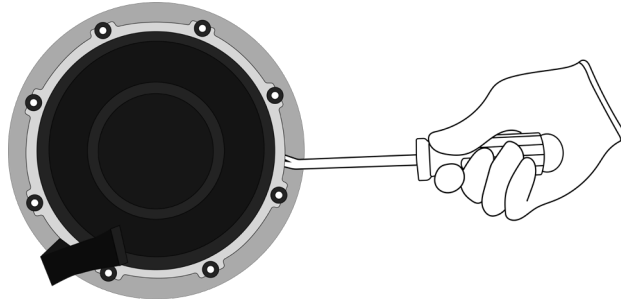

Tools Used

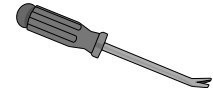

Fraction



Woofer

Cu

Copper

**12.** Remove the heat shield by unscrewing the three Torx T6 fasteners.

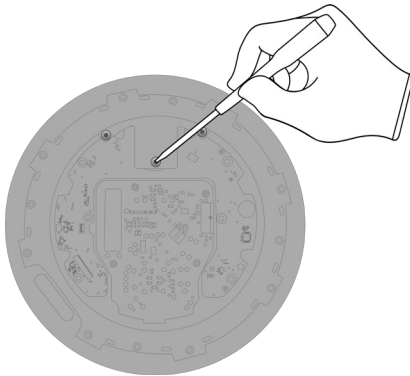

Tools Used



Fraction



Fasteners (x3)

Fe

Ferrous

Fraction



Heat shield

Fe

Ferrous

### 13. Separate the middle ring from the lower enclosure.

» Unscrew the eight Torx T6 fasteners.

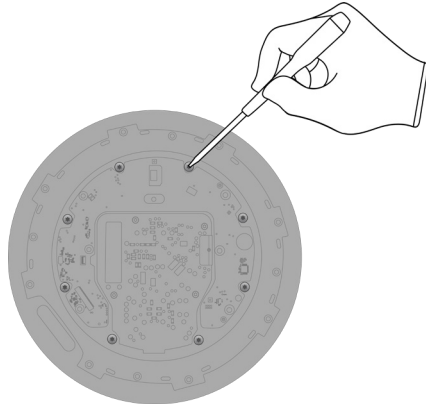

Tools Used

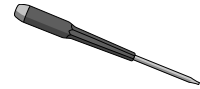

Fraction



Fasteners (x8)

Fe

Ferrous

» Remove the middle ring by hand. Set the lower enclosure aside.

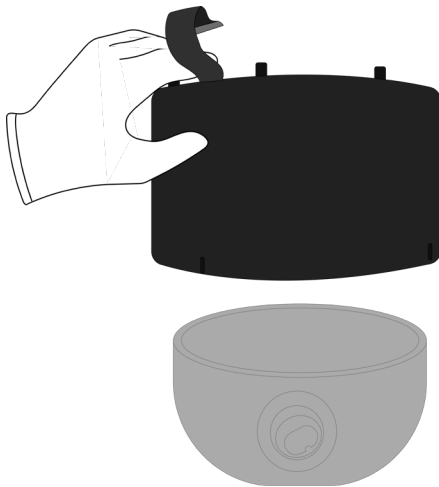

» Pull the ribbon cable off the middle ring.

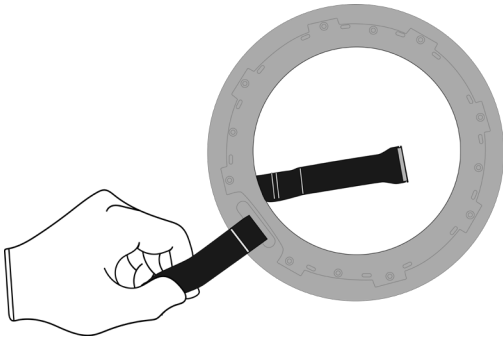

Fraction



Ribbon cable

Cu  
Copper

A diagram showing a black ribbon cable. Below it is a green box with the chemical symbol 'Cu' and the word 'Copper' underneath.

Fraction



Middle ring

PL  
Plastics

A diagram showing a black middle ring. Below it is a green box with the chemical symbol 'PL' and the word 'Plastics' underneath.

## 14. Remove the power supply logic board.

- » *Inside the lower enclosure, unscrew the six Torx T6 fasteners.*

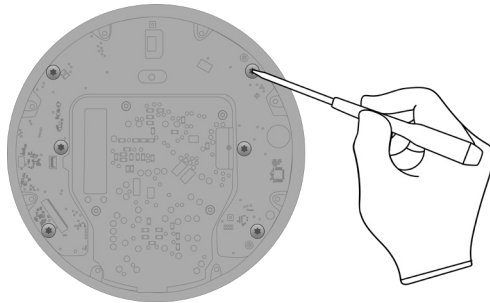

### Tools Used

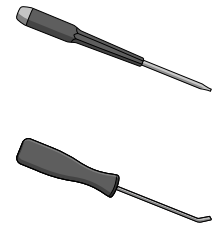

### Fraction



Fasteners (x6)

Fe

Ferrous

- » *Pry off the power supply logic board.*

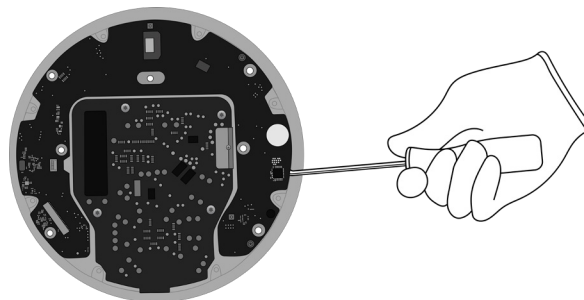

### Fraction

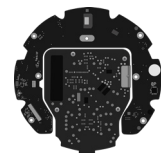

Power supply  
logic board

PMs

Precious  
Metals

## 15. Remove the tweeter cover.

» Unscrew the five Torx T4 fasteners.

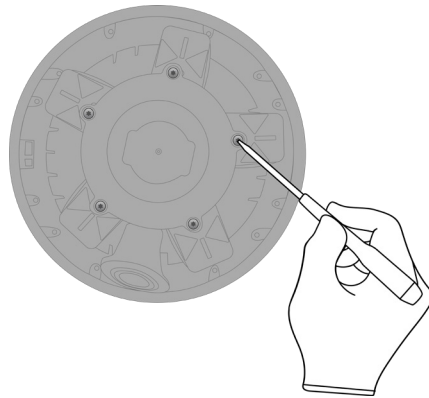

Tools Used

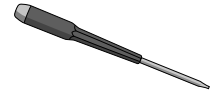

Fraction



Fasteners (x5)

Fe

Ferrous

» Pull out the tweeter cover by hand.

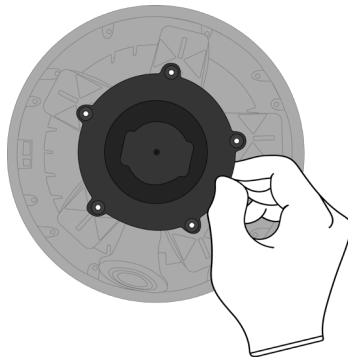

Fraction

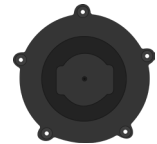

Tweeter cover

Fe

Ferrous

## 16. Remove the tweeters.

» Unscrew the 10 Torx T6 fasteners.

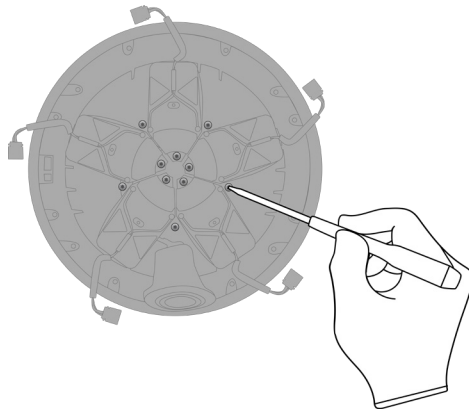

Tools Used

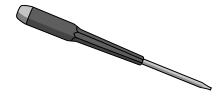

Fraction



Fasteners (x10)

Fe

Ferrous

» Pull out the five tweeters by hand.

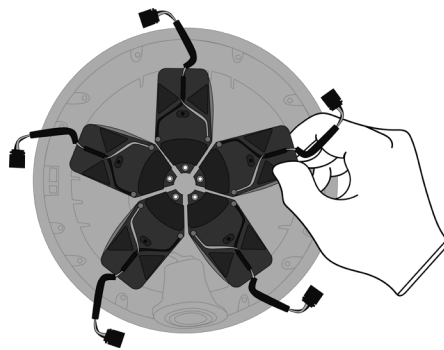

Fraction



Tweeters (x5)

REE

Rare Earth  
Elements

## 17. Remove the two ribbon cables from the lower enclosure.

» *Pry one ribbon cable off the inside wall of the enclosure.*

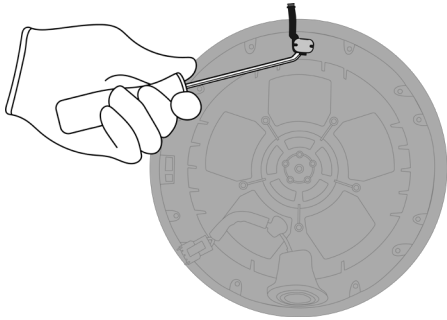

Tools Used



Fraction



Ribbon cable

Cu  
Copper

» *By hand, pull the other ribbon cable from the center.*

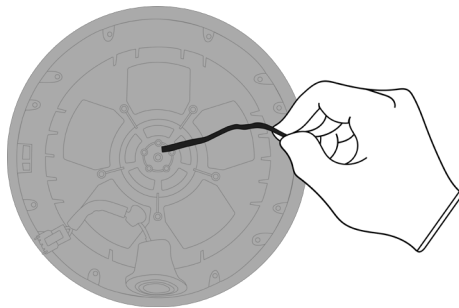

Fraction



Ribbon cable

Cu  
Copper



**18.** Pry off the interior power cord.

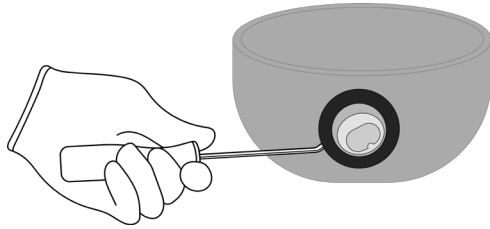

Tools Used



Fraction



*Interior power cord*

**Cu**  
Copper

Fraction

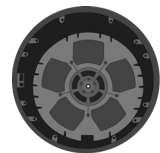

*Lower enclosure*

**PL**  
Plastics

# Material Categorization of Output Fractions

All outputs from this process must be managed, handled, and disposed of in accordance with applicable waste laws and regulations, including but not limited to the Waste Framework Directive and its national enactments in Europe.

Fraction	Downstream Processing
----------	-----------------------

## Ferrous



Fasteners (x57)

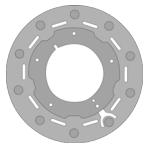

Fabric anchor



Heat shield

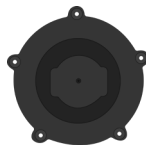

Tweeter cover

## Primary Target Material



## Glass

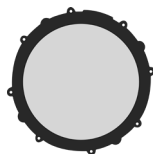

Touch assembly

## Primary Target Material



## Potential Additional Materials



**Fraction**

**Downstream Processing**

**Logic Boards**



*Main logic board*



*Power supply logic board*

**Primary Target Material**



**Potential Additional Materials**



**Mixed Electronics**



*Power cord*



*Touch sensor*



*Woofer*

**Primary Target Material**



**Potential Additional Materials**



**Fraction**

**Downstream Processing**

**Mixed Electronics (cont.)**

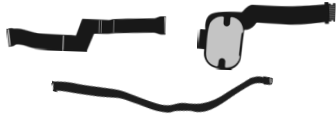

*Ribbon cables*

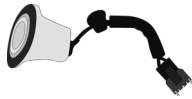

*Interior power cord*

**Mixed Plastics**

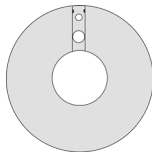

*Base*



*Fabric anchor flange*



*Fastener covers*

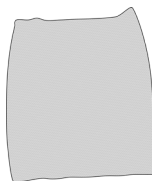

*Fabric module cover*

**Primary Target Material**



**Potential Additional Materials**



**Fraction**

**Downstream Processing**

**Mixed Plastics (cont.)**



*Upper ring*



*Middle ring*

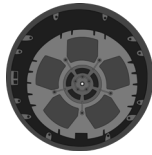

*Lower enclosure*

**Rare Earth Magnets**



*Tweeters*

**Primary Target Material**



**Potential Additional Materials**

