



Apple TV HD

Apple Recycler Guide

April 2023

Contents

- 3 [About This Guide](#)
- 4 [Identification](#)
- 5 [Directive 2012/19/EU Annex VII Components](#)
- 6 [Safety Considerations](#)
- 7 [Recommended Tools](#)
- 8 [Disassembly Instructions](#)
- 15 [Material Categorization of Output Fractions](#)

About This Guide

Apple Recycler Guides provide guidance for electronics recyclers on how to disassemble products to maximize recovery of resources. The guides provide step-by-step disassembly instructions and information on the material composition to help recyclers direct fractions to the appropriate material recycler.

To conserve important resources, we work to reduce the materials we use and aim to one day source only recycled or renewable materials in our products. A key path to reaching that goal is resource recovery from end-of-life electronics.

Disassembly procedures are intended to be performed only by trained electronics recycling professionals. The recycler is responsible for independently evaluating and ensuring compliance with all applicable environmental, health, and safety laws related to the work. These include but are not limited to laws relating to the management, handling, shipping, and disposal of the outputs of this work as waste and laws in place to ensure the health and safety of all employees who support this work.

For questions or feedback about this guide, email contactesci@apple.com.

Identification

You can find the model number on the bottom cover of the Apple TV HD.



Model number:
A1625

Directive 2012/19/EU Annex VII Components

Directive 2012/19/EU Annex VII requirements apply to the following substances and components.

Substance/Component	Apple Part Name	Removal Instructions
Printed circuit board if the surface is greater than 10 square centimeters	Main logic board, power supply logic board	Follow steps 1–6
External electric cables	Power cord	Follow step 1
No further substances or components as listed in Annex VII		

Safety Considerations

The recycler is responsible for independently evaluating all activities undertaken by its employees to perform or support the work and ensuring compliance with all applicable health and safety laws related to the work. These include but are not limited to laws relating to the health and safety of all employees who perform or support this work. The recycler is also responsible for evaluating the workspace and ensuring that the area in which the work is to be undertaken is designed using ergonomic best practices and meets all ergonomic requirements to ensure the protection of its employees.

Personal Protective Equipment

Personal protective equipment should be worn during the entire recycling process.



Wear hand protection



Wear protective clothing



Wear eye protection



Wear foot protection

Recommended Tools

Nail-pulling screwdriver

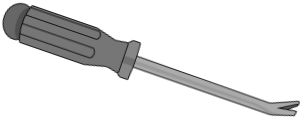

Torx T5 screwdriver

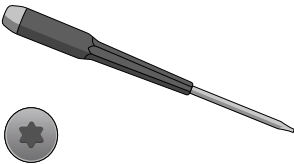

Torx T7 screwdriver

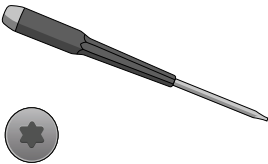

Disassembly Instructions

1. Remove the power cord.

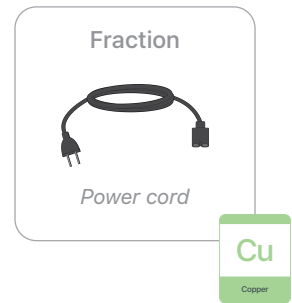

Warning: Before continuing disassembly, wait 10 minutes after unplugging the device for stored energy to discharge.

2. Pry off the bottom cover.

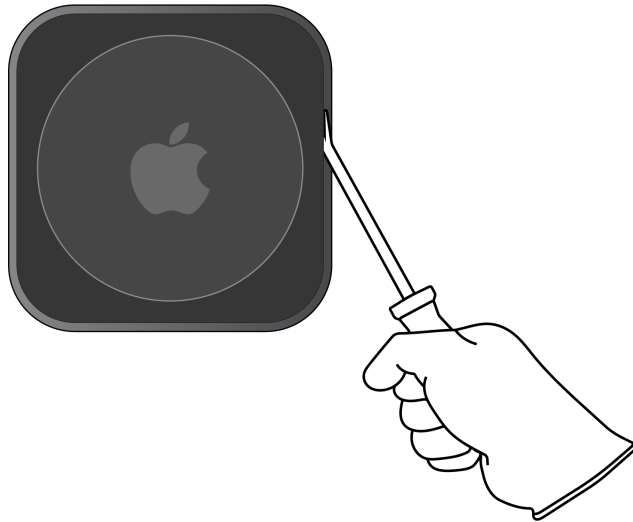

Tools Used

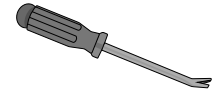

Fraction



Bottom cover

PL

Plastics

3. Remove the EMI shield.

» Unscrew the five Torx T7 fasteners.

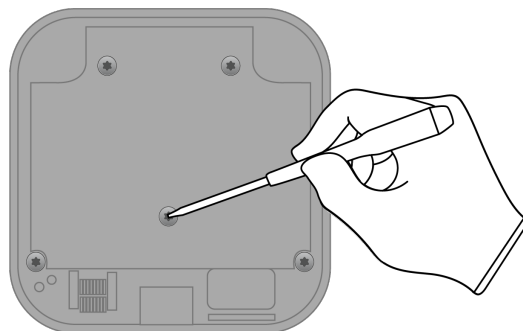

Tools Used

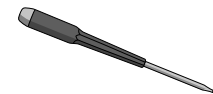

Fraction



Fasteners (x5)

Fe

Ferrous

» Lift off the EMI shield.

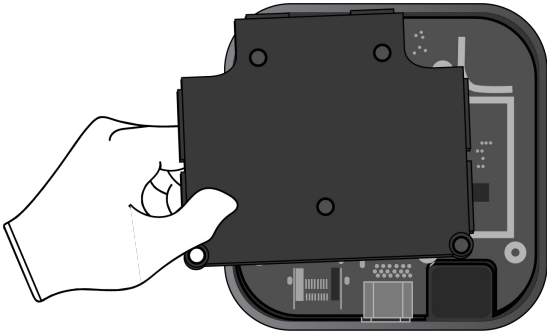

Fraction

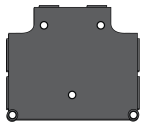

EMI shield

AI

Aluminum

This block contains a diagram of the EMI shield component, a label 'EMI shield', and a green box with 'AI' and 'Aluminum' below it.

4. Pry the main logic board off the heat sink.

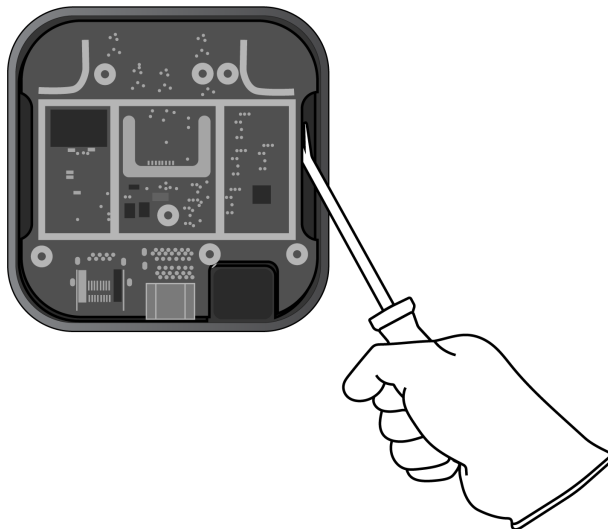

Tools Used



This block contains a diagram of a screwdriver.

Fraction

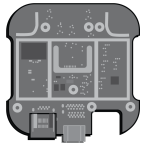

Main logic board

PMs

Precious Metals

This block contains a diagram of the main logic board component, a label 'Main logic board', and a green box with 'PMs' and 'Precious Metals' below it.

5. Separate the heat sink from the enclosure.

» Unscrew the four Torx T7 fasteners.

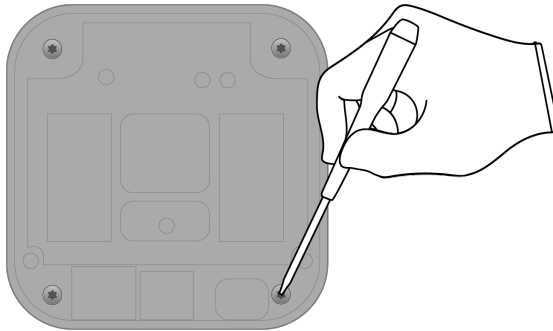

Tools Used

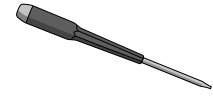

Fraction



Fasteners (x4)

Fe

Ferrous

» Pry the heat sink out of the enclosure.

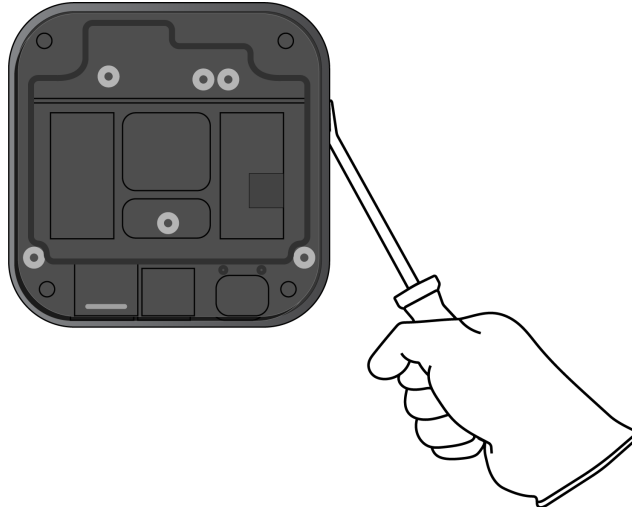

Tools Used

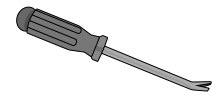

Fraction



Enclosure

PL

Plastics

6. Remove the power supply logic board.

- » *Unscrew the six Torx T7 fasteners from the underside of the heat sink.*

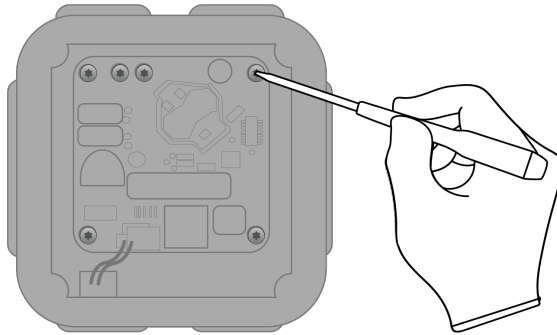

Tools Used

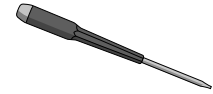

Fraction



Fasteners (x6)

Fe

Ferrous

- » *Lift off the power supply logic board.*

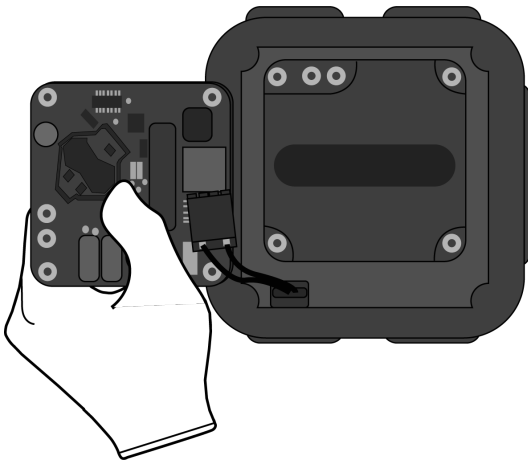

Fraction

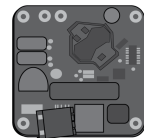

Power supply logic board

PMs

Precious Metals

7. Separate the AC connector from the heat sink.

- » *Turn over the heat sink.*
- » *Unscrew the two Torx T5 fasteners.*

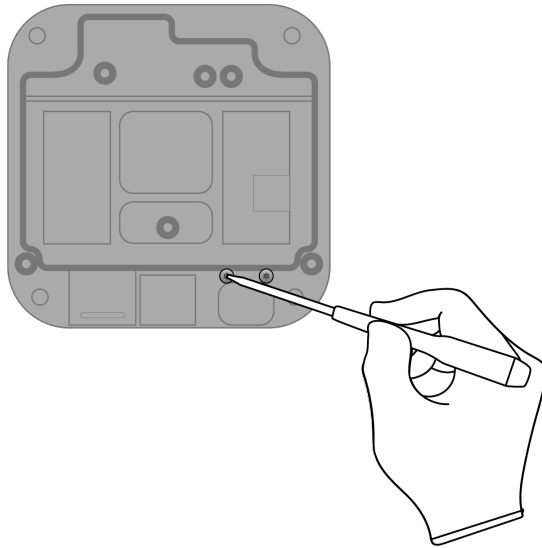

Tools Used

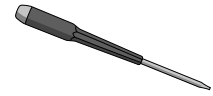

Fraction



Fasteners (x2)

Fe



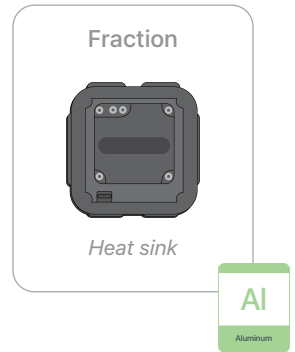
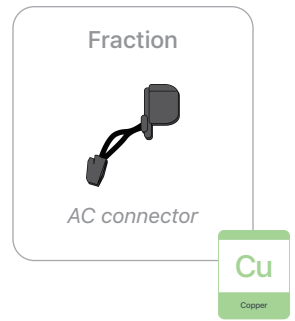
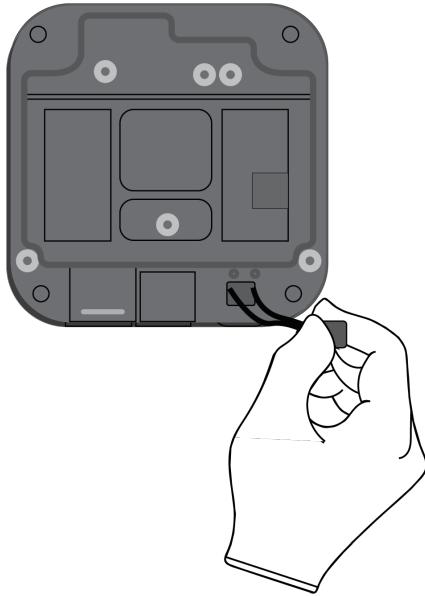

Ferrous

» Lift off the AC connector.

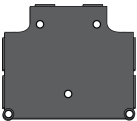

Material Categorization of Output Fractions

All outputs from this process must be managed, handled, and disposed of in accordance with applicable waste laws and regulations, including but not limited to the Waste Framework Directive and its national enactments in Europe.

Fraction	Downstream Processing
<p>Aluminum</p>  <p><i>EMI shield</i></p>  <p><i>Heat sink</i></p>	<p>Primary Target Material</p>  <p>Potential Additional Materials</p>  

<p>Ferrous</p>  <p><i>Fasteners (x17)</i></p>	<p>Primary Target Material</p> 
---	---

Fraction

Downstream Processing

Logic Boards

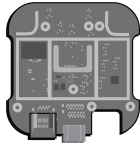

Main logic board

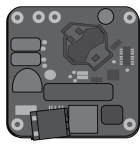

Power supply logic board

Primary Target Material



Potential Additional Materials



Mixed Electronics



Power cord



AC connector

Primary Target Material



Potential Additional Materials



Fraction

Downstream Processing

Mixed Plastics



Bottom cover



Enclosure

Primary Target Material

